

Victaulic® Series 776 Low Pressure Actuator



1.0 PRODUCT DESCRIPTION

Pressure Class

- Up to 300 psi/2068 kPa/20 bar

Connection

- Threaded

Valve Configurations

- Series 768N FireLock NXT™ Dry System Check Valve
- Series 769N FireLock NXT™ Deluge System Check Valve
- Series 769N FireLock NXT™ Preaction System Check Valve
- Series 756 FireLock™ Dry System Check Valve
- Series 758 FireLock™ Actuated System Valve

Operational Pressures

- Normal range: 13-18 psi
- Set pressure: 10 psi
- Trip pressure: 7 psi

NOTE

- If a Series 746 accelerator is in use, normal range may differ.

2.0 CERTIFICATION/LISTINGS



NOTE

- Product approvals for some agencies may be tied to the overall product listed above.

ALWAYS REFER TO ANY NOTIFICATIONS AT THE END OF THIS DOCUMENT REGARDING PRODUCT INSTALLATION, MAINTENANCE OR SUPPORT.

3.0 SPECIFICATIONS – MATERIAL

Lower Chamber: Durable cast bronze

Middle and Upper Chambers: Brass conforming to UNS C36000

Internal Components: Brass conforming to UNS C36000

Seals: EPDM

Fasteners: 300 series stainless steel

Springs: Stainless steel

Strainer: Brass conforming to UNS C36000

Eyelets: Brass conforming to UNS C36000

O-ring: Buna N

Diaphragms: EPDM

4.0 DIMENSIONS

Series 776 Manual Handle

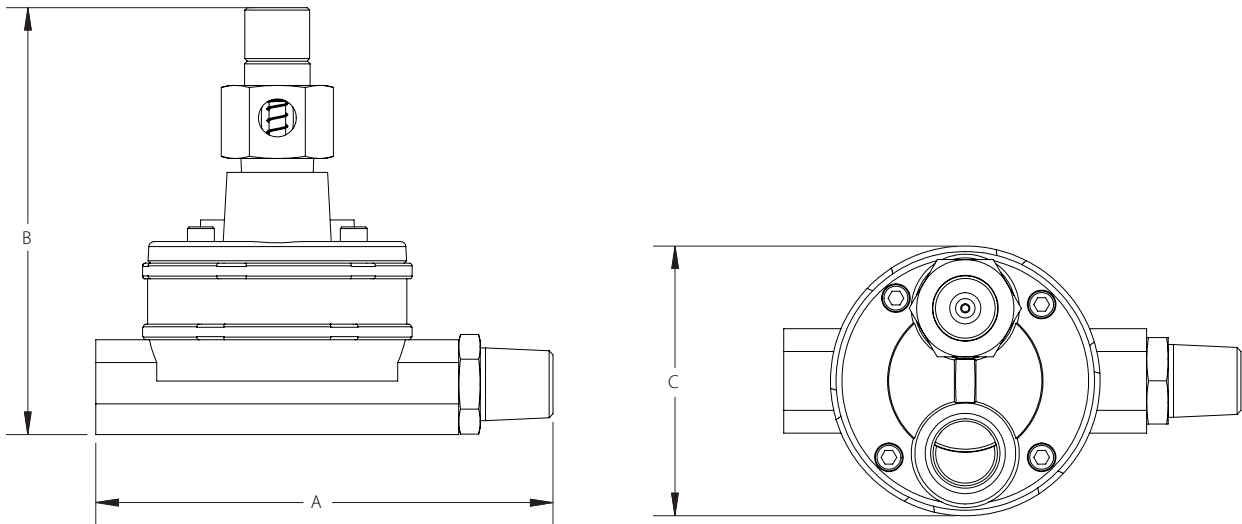

Size		Dimensions			Weight
Nominal inches DN	Actual Outside Diameter inches mm	A inches mm	B inches mm	C inches mm	Approximate (Each) lb kg
1/2 DN15	0.840 21.3	5.29 134	5.00 126	3.13 80	4.6 2.1

5.0 PERFORMANCE

Series 776

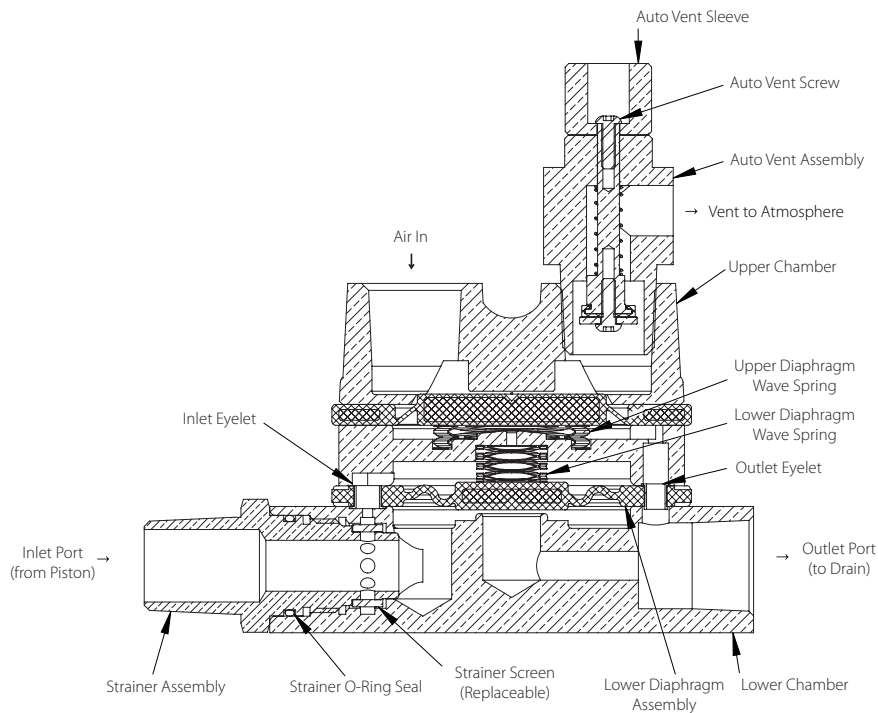

The Series 776 Low-Pressure Actuator is located on the trim of pneumatically released Victaulic dry, deluge, and preaction valves and comes standard on the Series 768 Dry, 769 Deluge, and 769 Preaction FireLock NXT Valves. The Series 776 acts as the trigger for these systems.

Diaphragms separate the low-pressure actuator into three chambers. The upper air chamber controls the activation, while the middle and lower chambers act as the water valve.

During charging, the system feeds air into the upper chamber of the low-pressure actuator. Pulling up on the Auto Vent's knob, which is located on top of the low-pressure actuator, manually sets the upper chamber. The air pressure in the upper chamber holds the Auto Vent closed, while it exerts force on the water seal of the middle chamber.

When you open the piston charge line of the sprinkler control valve trim, water enters the lower chamber of the low-pressure actuator. The water entering the low-pressure actuator flows to the middle chamber through the inlet eyelet. This water is trapped in the middle chamber by the upper diaphragm assembly, which is held closed by the system air pressure in the upper chamber.

Since the area of the lower diaphragm, which is exposed to the middle chamber's water pressure, is greater than the area of the lower chamber, the lower chamber seals off. No water flows to the low-pressure actuator's outlet,







and the supply water pressure creates the water seal.

When the system air pressure decays to 7 psi/45 kPa, the force exerted by the compression spring in the auto vent is greater than the force exerted by the air in the upper chamber. The Auto Vent opens and the air pressure in the upper chamber evacuates. The upper diaphragm then releases the water pressure in the low-pressure actuator's middle chamber, which allows the lower diaphragm to lift and water to flow from the low-pressure actuator's inlet to the outlet. This water flow releases water pressure from the control valve's piston, thus allowing the piston to retract. The control valve's clapper opens and water flows into the sprinkler system.

Auto Vent

After the actuated check valve operates, water will enter the air line portion of the trim. This is connected to the upper chamber of the LPA and controls its actuation. Should the upper chamber become pressurized, the LPA could close prematurely. The Series 748 ball check in the valve trim prevents most of this water from entering the LPA, but in case of ball check malfunction, the Auto Vent of the Series 776 Low Pressure Actuator acts as an anti-flood device. When the Auto Vent opens, the system is configured such that fluid entering the LPA upper chamber is allowed to flow through the Auto Vent faster than it can enter the LPA upper chamber. In this way, it is not possible to develop pressure in the upper chamber without manual intervention.

6.0 NOTIFICATIONS

 WARNING	
    	<ul style="list-style-type: none"> • Read and understand all instructions before attempting to install any Victaulic products. • Always verify that the piping system has been completely depressurized and drained immediately prior to installation, removal, adjustment, or maintenance of any Victaulic products. • Wear safety glasses, hardhat, and foot protection.
<ul style="list-style-type: none"> • These products shall be used only in fire protection systems that are designed and installed in accordance with current, applicable National Fire Protection Association (NFPA 13, 13D, 13R, etc.) standards, or equivalent standards, and in accordance with applicable building and fire codes. These standards and codes contain important information regarding protection of systems from freezing temperatures, corrosion, mechanical damage, etc. • The installer shall understand the use of this product and why it was specified for the particular application. • The installer shall understand common industry safety standards and potential consequences of improper product installation. 	

7.0 REFERENCE MATERIALS

- [30.22: SERIES 7C7 Air Maintenance/Compressor Assembly](#)
- [30.23: FireLock™ Fire-Pac Series 745](#)
- [30.35: SERIES 757 FireLock® Devices Air Maintenance Trim Assembly](#)
- [30.36: FireLock® Devices SERIES 757P AIR MAINTENANCE TRIM ASSEMBLY](#)
- [30.64: SERIES 746-LPA FireLock® Dry Accelerator](#)
- [31.80: Victaulic® FireLock NXT™ Dry Valve Series 768N](#)
- [31.81: Victaulic® FireLock NXT™ Deluge Valve Series 769N](#)
- [31.82: Victaulic® FireLock NXT™ Preaction Trim Series 769N](#)
- [I-768N: Series 768N FireLock NXT™ Dry Valve](#)
- [I-769N.Deluge: Series 769N FireLock NXT™ Deluge Valve](#)
- [I-769N.Preaction: Victaulic® Series 769N FireLock NXT™ Actuated Valve with Preaction Trim](#)

User Responsibility for Product Selection and Suitability

Each user bears final responsibility for making a determination as to the suitability of Victaulic products for a particular end-use application, in accordance with industry standards and project specifications, as well as Victaulic performance, maintenance, safety, and warning instructions. Nothing in this or any other document, nor any verbal recommendation, advice, or opinion from any Victaulic employee, shall be deemed to alter, vary, supersede, or waive any provision of Victaulic Company's standard conditions of sale, installation guide, or this disclaimer.

Intellectual Property Rights

No statement contained herein concerning a possible or suggested use of any material, product, service, or design is intended, or should be construed, to grant any license under any patent or other intellectual property right of Victaulic or any of its subsidiaries or affiliates covering such use or design, or as a recommendation for the use of such material, product, service, or design in the infringement of any patent or other intellectual property right. The terms "Patented" or "Patent Pending" refer to design or utility patents or patent applications for articles and/or methods of use in the United States and/or other countries.

Note

This product shall be manufactured by Victaulic or to Victaulic specifications. All products to be installed in accordance with current Victaulic installation/assembly instructions. Victaulic reserves the right to change product specifications, designs and standard equipment without notice and without incurring obligations.

Installation

Reference should always be made to the Victaulic installation handbook or installation instructions of the product you are installing. Handbooks are included with each shipment of Victaulic products, providing complete installation and assembly data, and are available in PDF format on our website at www.victaulic.com.

Warranty

Refer to the Warranty section of the current Price List or contact Victaulic for details.

Trademarks

Victaulic and all other Victaulic marks are the trademarks or registered trademarks of Victaulic Company, and/or its affiliated entities, in the U.S. and/or other countries.