

Victaulic® FireLock™ Series FL-ECLH/SWDC

Extended Coverage, Quick Response

Domed Concealed and Horizontal Sidewall Sprinklers

K5.6 (8.1), K8.0 (11.5)

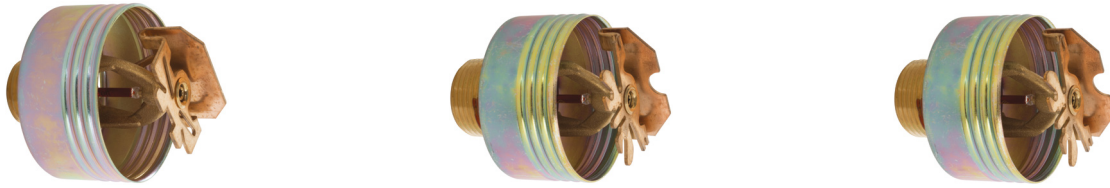

1.0 PRODUCT DESCRIPTION

QUICK RESPONSE DOMED CONCEALED HORIZONTAL SIDEWALL			
SIN	V5613	V8113	V8114
ORIENTATION	Domed Concealed Horizontal Sidewall	Domed Concealed Horizontal Sidewall	Domed Concealed Horizontal Sidewall
K-FACTOR ¹	5.6 Imp./8.1 S.I.	8.0 Imp./11.5 S.I.	8.0 Imp./11.5 S.I.
CONNECTION	½" NPT/15mm BSPT	¾" NPT/ 20mm BSPT	¾" NPT/ 20mm BSPT
MAX. WORKING PRESSURE	175 psi (1200 kPa)	175 psi (1200 kPa)	175 psi (1200 kPa)
GLOBE RE-DESIGNATION	GL5613	GL8113	GL8114

AVAILABLE WRENCHES			
SPRINKLER	V56-2 Recessed	V11-2 Recessed	V11-2 Recessed
SIDEWALL	■	■	■

Factory Hydrostatic Test: 100% @ 500 psi/3447 kPa/34 bar

Min. Operating Pressure: UL: 7psi/48 kPa/5 bar

Temperature Rating: See tables in section 2.0

¹ For K-Factor when pressure is measured in bar, multiply S.I. units by 10.0.

2.0 CERTIFICATION/LISTINGS



SIN		V5613						
Nominal K Factor Imperial		5.6						
Nominal K Factor S.I. ²		8.1						
Installation Type		Domed Concealed Horizontal Sidewall						Minimum Spacing Ft. m
Maximum Coverage Area Width x Length Ft. x Ft m x m	Listing Agency	Top of Deflector Ceiling in mm	Response	Flow GPM L/min	Pressure PSI kPa	Approved Temperature Ratings F°/C°	Approved Coverplate Temperature Ratings F°/C°	
16 x 18 4.9 x 5.5	cULus	4 – 6 100 – 150	QR	29 110	26.8 185	135°F/57°C 155°F/68°C 175°F/79°C	135°F/57°C 135°F/57°C 155°F/68°C	8 2.4
	cULus	6 – 12 150 – 300	QR	32 121	32.7 225	135°F/57°C 155°F/68°C 175°F/79°C	135°F/57°C 135°F/57°C 155°F/68°C	
16 x 20 4.9 x 6.1	cULus	4 – 6 100 – 150	QR	32 121	32.7 225	135°F/57°C 175°F/79°C	135°F/57°C 155°F/68°C	
	cULus	6 – 12 150 – 300	QR	32 121	32.7 225	135°F/57°C 175°F/79°C	135°F/57°C 155°F/68°C	

² For K-Factor when pressure is measured in bar, multiply S.I. units by 10.0.

NOTE

- Listings and approval as of printing.
- These sprinklers are required to be vented. Installations with a positive pressure air plenum above the housing are not permitted.

ALWAYS REFER TO ANY NOTIFICATIONS AT THE END OF THIS DOCUMENT REGARDING PRODUCT INSTALLATION, MAINTENANCE OR SUPPORT.



2.0 CERTIFICATION/LISTINGS



SIN			V8113					
Nominal K Factor Imperial			8.0					
Nominal K Factor S.I. ²			11.5					
Installation Type			Domed Concealed Horizontal Sidewall					Minimum Spacing Ft. m
Maximum Coverage Area Width x Length Ft. x Ft m x m	Listing Agency	Top of Deflector Ceiling in mm	Response	Flow GPM L/min	Pressure PSI kPa	Approved Temperature Ratings F°/C°	Approved Coverplate Temperature Ratings F°/C°	
16 x 16 4.9 x 4.9	cULus	4 – 12 100 – 300	QR	26 98	10.6 73	135°F/57°C 155°F/68°C 175°F/79°C	135°F/57°C 135°F/57°C 155°F/68°C	8 2.4
16 x 18 4.9 x 5.5	cULus	4 – 6 100 – 150	QR	29 110	13.1 90	135°F/57°C 155°F/68°C 175°F/79°C	135°F/57°C 135°F/57°C 155°F/68°C	
	cULus	6 – 12 150 – 300	QR	32 121	16.0 110	135°F/57°C 155°F/68°C 175°F/79°C	135°F/57°C 135°F/57°C 155°F/68°C	
16 x 20 4.9 x 6.1	cULus	4 – 6 100 – 150	QR	32 121	16.0 110	135°F/57°C 155°F/68°C 175°F/79°C	135°F/57°C 135°F/57°C 155°F/68°C	
	cULus	6 – 12 150 – 300	QR	37 140	21.4 148	135°F/57°C 175°F/79°C	135°F/57°C 155°F/68°C	

SIN			V8114					
Nominal K Factor Imperial			8.0					
Nominal K Factor S.I. ²			11.5					
Installation Type			Domed Concealed Horizontal Sidewall					Minimum Spacing Ft. m
Maximum Coverage Area Width x Length Ft. x Ft m x m	Listing Agency	Top of Deflector Ceiling in mm	Response	Flow GPM L/min	Pressure PSI kPa	Approved Temperature Ratings F°/C°	Approved Coverplate Temperature Ratings F°/C°	
16 x 22 4.9 x 6.7	cULus	4 – 6 100 – 150	QR	36 136	20.3 140	135°F/57°C	135°F/57°C	8 2.4
16 x 24 4.9 x 7.3	cULus	4 – 6 100 – 150	QR	39 148	23.8 164	135°F/57°C	135°F/57°C	
18 x 20 5.1 x 6.1	cULus	4 – 12 100 – 300	QR	36 136	20.3 140	135°F/57°C	135°F/57°C	
18 x 22 5.1 x 6.7	cULus	4 – 12	QR	40	25.0	135°F/57°C	135°F/57°C	
		100 – 300		151	172			

² For K-Factor when pressure is measured in bar, multiply S.I. units by 10.0.

NOTE

- Listings and approval as of printing.

3.0 SPECIFICATIONS – MATERIAL

Deflector: Bronze

Bulb Nominal Diamter: 3.0 mm

Load Screw: Brass

Pip Cap: Brass

Spring Seal: PTFE coated Beryllium nickel alloy

Frame: Brass

Concealed Cup: Steel

Cover Plate: Steel

Lodgement Spring: Stainless Steel

Installation Wrench: Ductile Iron

Cover Plate Finishes:

- Chrome plated
- White painted
- Flat black painted
- Custom painted

NOTE

- For cabinets and other accessories refer to separate sheet.

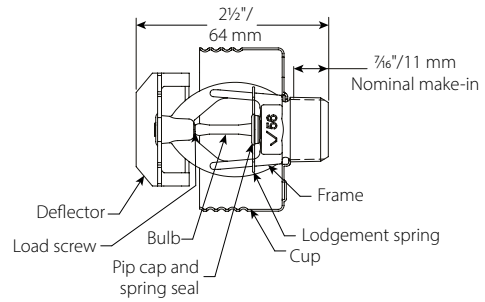

V5613, V8113, V8114

4.0 DIMENSIONS

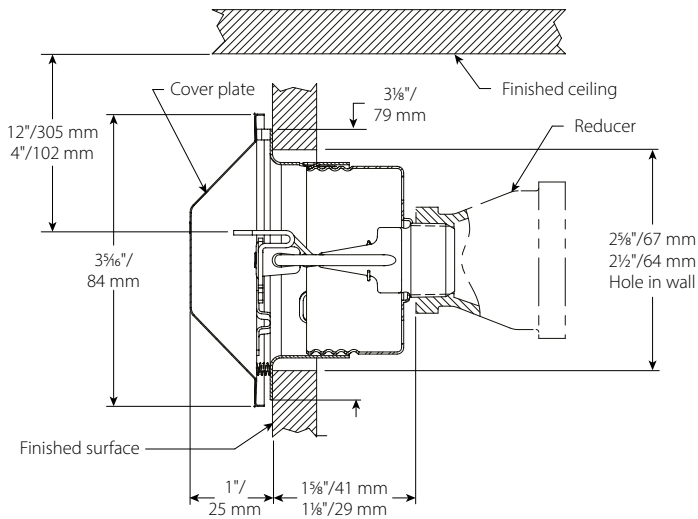







V5613, V8113, V8114

5.0 PERFORMANCE

Sprinkler is to be installed and designed as per NFPA, FM Datasheets, or any local standards.

6.0 NOTIFICATIONS

 WARNING	
    	<ul style="list-style-type: none">• Read and understand all instructions before attempting to install any Victaulic products.• Always verify that the piping system has been completely depressurized and drained immediately prior to installation, removal, adjustment, or maintenance of any Victaulic products.• Wear safety glasses, hardhat, and foot protection. <p>Failure to follow these instructions could result in death or serious personal injury and property damage.</p>
<ul style="list-style-type: none">• These products shall be used only in fire protection systems that are designed and installed in accordance with current, applicable National Fire Protection Association (NFPA 13, 13D, 13R, etc.) standards, or equivalent standards, and in accordance with applicable building and fire codes. These standards and codes contain important information regarding protection of systems from freezing temperatures, corrosion, mechanical damage, etc.• The installer shall understand the use of this product and why it was specified for the particular application.• The installer shall understand common industry safety standards and potential consequences of improper product installation.• It is the system designer's responsibility to verify suitability of materials for use with the intended fluid media within the piping system and external environment.• The material specifier shall evaluate the effect of chemical composition, pH level, operating temperature, chloride level, oxygen level, and flow rate on materials to confirm system life will be acceptable for the intended service. <p>Failure to follow installation requirements and local and national codes and standards could compromise system integrity or cause system failure, resulting in death or serious personal injury and property damage.</p>	

7.0 REFERENCE MATERIALS

Ratings: All glass bulbs are rated for temperatures from -67°F/-55°C.

[1-40: Victaulic FireLock™ Automatic Sprinklers Installation and Maintenance Instructions](#)

[1-V9: Style V9 Victaulic FireLock™ IGS™ Installation-Ready™ Sprinkler Coupling Installation Instructions](#)

User Responsibility for Product Selection and Suitability

Each user bears final responsibility for making a determination as to the suitability of Victaulic products for a particular end-use application, in accordance with industry standards and project specifications, as well as Victaulic performance, maintenance, safety, and warning instructions. Nothing in this or any other document, nor any verbal recommendation, advice, or opinion from any Victaulic employee, shall be deemed to alter, vary, supersede, or waive any provision of Victaulic Company's standard conditions of sale, installation guide, or this disclaimer.

Intellectual Property Rights

No statement contained herein concerning a possible or suggested use of any material, product, service, or design is intended, or should be construed, to grant any license under any patent or other intellectual property right of Victaulic or any of its subsidiaries or affiliates covering such use or design, or as a recommendation for the use of such material, product, service, or design in the infringement of any patent or other intellectual property right. The terms "Patented" or "Patent Pending" refer to design or utility patents or patent applications for articles and/or methods of use in the United States and/or other countries.

Note

This product shall be manufactured by Victaulic or to Victaulic specifications. All products to be installed in accordance with current Victaulic installation/assembly instructions. Victaulic reserves the right to change product specifications, designs and standard equipment without notice and without incurring obligations.

Installation

Reference should always be made to the Victaulic installation handbook or installation instructions of the product you are installing. Handbooks are included with each shipment of Victaulic products, providing complete installation and assembly data, and are available in PDF format on our website at www.victaulic.com.

Warranty

Refer to the Warranty section of the current Price List or contact Victaulic for details.

Trademarks

Victaulic and all other Victaulic marks are the trademarks or registered trademarks of Victaulic Company, and/or its affiliated entities, in the U.S. and/or other countries.