

Hang these instructions
in a visible location on the
installed valve for easy
future reference.

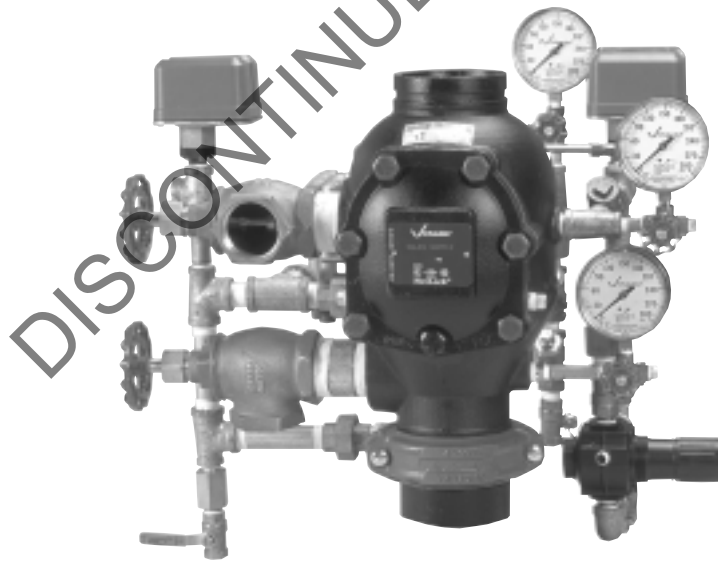

Series 758 FireLock™ Actuated System Valve With Preaction Trim and Series 753-A Dry Actuator and/or Solenoid Valve Installation, Maintenance, and Testing Manual



WARNING



Failure to follow Instructions and warnings can result in serious injury.

- Always read and understand all installation instructions before attempting assembly of Victaulic piping products.
- Always wear safety glasses and foot protection.
- Failure to do so could result in serious personal injury, property damage, and/or valve leakage.

If you need additional copies of this manual, or if you have any questions about the safe operation of this valve, contact Victaulic Company, P.O. Box 31, Easton, PA 18044-0031, USA, Telephone: 001-610-559-3300.

TABLE OF CONTENTS

Table of Contents	2	Required Tests	11
Important Information	2	Trip Test	13
Installer Safety Instructions	3	Maintenance	14
Introduction	4	Removing the Rubber Clapper Facing	16
Exploded View Drawings	4	Installing the Rubber Clapper Seal	16
Dimensions	5	Removing the Clapper Assembly	17
Air Maintenance Trim	6	Installing the Clapper	17
Installation	7	Removing the Actuator Piston	18
Important Settings	7	Installing the Cover Plate	18
Placing the System in Service	8	Troubleshooting	19
Inspection and Tests	11	Warranty	19
Weekly Inspection	11	Facilities Locations	B/C

⚠ WARNING	
	<ul style="list-style-type: none"> This product must be installed by an experienced, trained installer, in accordance with the instructions provided with each valve. These instructions contain important information. <p>Failure to follow these instructions may result in serious personal injury, property damage, and/or valve leakage. If you need additional copies of this literature, or if you have any questions about the safe installation and use of this device, contact Victaulic Company, P.O. Box 31, Easton, PA 18044-0031 USA, Telephone: 001-610-559-3300.</p>

Important Information

Definitions for identifying the various hazard levels shown on warning labels, or to indicate proper safety procedures in this instruction manual, are provided below.



This safety alert symbol indicates important safety messages on warning labels in this instruction manual. When you see this symbol, be alert to the possibility of personal injury. Carefully read and fully understand the message that follows.

⚠ WARNING
<p>The use of the word “WARNING” signifies the presence of hazards or unsafe practices, which could result in severe personal injury if instructions, including recommended precautions, are not followed.</p>

⚠ CAUTION
<p>The use of the word “CAUTION” signifies possible hazards or unsafe practices, which could result in minor personal injury, product, or property damage if instructions, including precautions, are not followed.</p>

NOTICE
<p>The use of the word “NOTICE” signifies special instructions, which are important but not related to hazards.</p>

INSTALLER SAFETY INSTRUCTIONS

⚠ WARNING	
	<ul style="list-style-type: none">• This product must be installed by an experienced, trained installer, in accordance with the instructions provided with each valve. These instructions contain important information. <p>Failure to follow these instructions may result in serious personal injury, property damage, and/or valve leakage.</p> <p>If you need additional copies of this literature, or if you have any questions about the safe installation and use of this device, contact Victaulic Company, P.O. Box 31, Easton, PA 18044-0031 USA, Telephone: 001-610-559-3300.</p>

GENERAL

1. Read and understand this manual before proceeding with installation, maintenance, and testing of the Victaulic Fire Protection Device. This product must be installed by an experienced, trained installer, in accordance with instructions provided with each valve. These instructions contain important information. Additional copies of this literature are available at no charge. If you need additional copies, or if you have any questions about the safe installation and use of this device, contact Victaulic Company, P.O. Box 31, Easton, PA 18044-0031 USA, Telephone: 001-610-559-3300.

2. Use only recommended accessories. Use of improper accessories or equipment in conjunction with these fire protection devices may result in improper operation of the system.

3. Avoid dangerous environments. If utilizing electrically-powered tools for installation, ensure that the area is free of moisture or wetness, which could create an unsafe condition. Keep work area well illuminated. Allow sufficient space for the device, trim, and accessories, plus sufficient space to accommodate proper installation.

4. Prevent back injury. Larger and pre-trimmed valves may be sufficiently heavy. Installation may require more than one person, or mechanical lifting equipment, to position the device properly. Utilize proper lifting techniques and be aware of the possible need for assistance.

5. Inspect the equipment. Be sure that all parts are included, and that you have all necessary tools available to install the device properly.

6. Wear safety glasses, hardhat, and safety footwear. Always practice safety first.

7. Watch for pinch points. Do not put fingers under the valve base where they could be pinched by the weight of the valve. Exercise caution around spring-loaded components, such as the swing clapper, clapper locking latch, and piston spring assembly.

8. Keep work area clean. Cluttered areas, benches, and slippery floors invite accidents.

9. Wear ear protection. Your hearing should be protected if exposed to long periods of very noisy job-site or shop operations.

10. Keep visitors away. All visitors should be kept a safe distance away from the work area.

MAINTENANCE AND TESTING

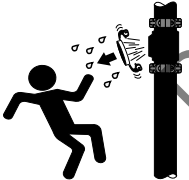
⚠ WARNING	
	<ul style="list-style-type: none">• Piping systems must always be depressurized and drained before attempting disassembly of any Victaulic piping products. <p>Failure to do so could result in serious personal injury, property damage, and/or valve leakage.</p>

1. Always notify the authority having jurisdiction. Any system service that requires taking a control valve or alarm valve out of service may eliminate the fire protection provided by the system. Prior to servicing or testing the system, notify the authority having jurisdiction of the operation being performed.

2. Always depressurize the system before attempting any maintenance work. Water under pressure, trapped air, or system air pressure may be present and must be fully deactivated and depressurized prior to proceeding with any service work, disassembly, or removal of any parts.

3. Follow NFPA requirements for system testing and inspection schedules. The authority having jurisdiction may mandate more frequent or additional tests or inspections.

4. Keep system free from freezing (wet systems), foreign matter or corrosive atmospheres. Any condition, which might degrade the system or adversely affect system performance, must be avoided.

5. Depressurize valve before removing cover plate bolts. The cover may blow off if these bolts are removed while the valve is pressurized.

INTRODUCTION

! WARNING



- Always read and understand all installation instructions before attempting assembly of Victaulic piping products.

Failure to do so could result in serious personal injury, property damage, and/or valve leakage.

! WARNING



- Piping systems must always be depressurized and drained before attempting disassembly of any Victaulic piping products.

Failure to do so could result in serious personal injury, property damage, and/or valve leakage.

The following procedures are a guide for proper assembly of Victaulic Series 758 Actuated System Valves with Preaction Trim.

These instructions are based on pipe prepared and grooved properly in accordance with the latest published Victaulic grooving specifications.

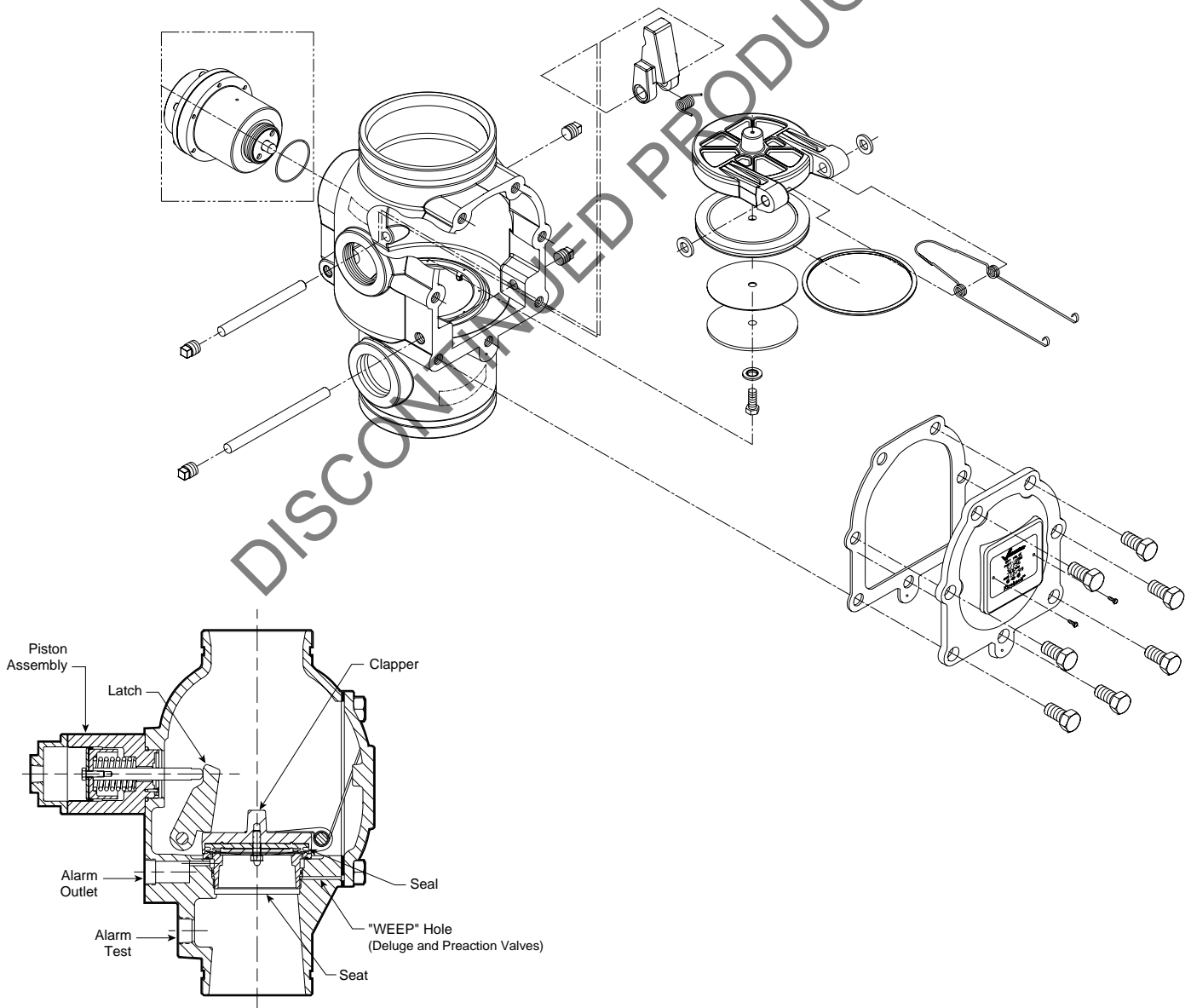

DIMENSIONS

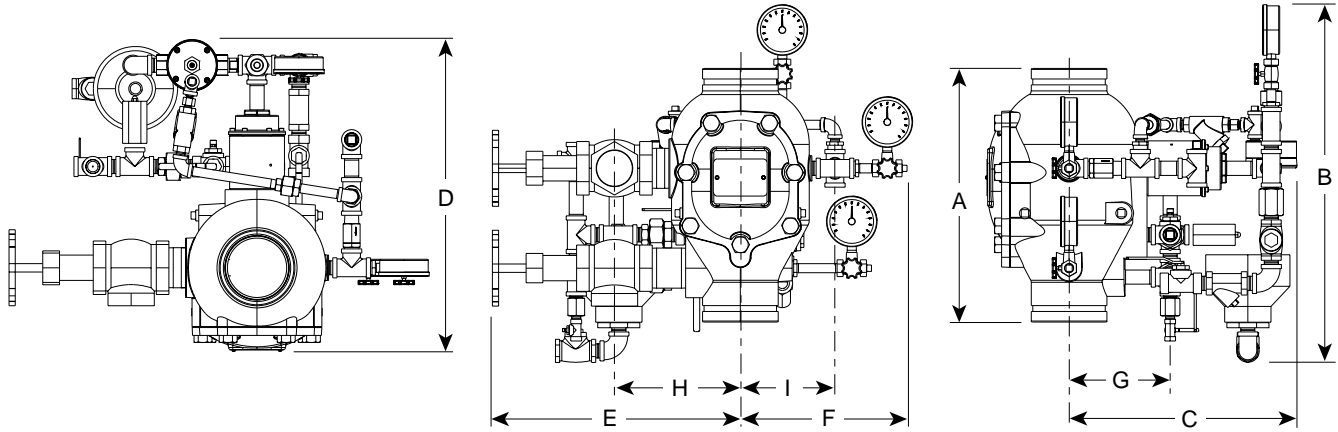

10.35-1B

VALVE SIZE Nominal Inches Actual mm	Dimensions Inches/mm									Aprx. Weight Each Lbs./kg			
	A	B	C	D	E	F	G	H	I	Without Trim		With Trim	
										Flanged	Grooved	Flanged	Grooved
GROOVED X GROOVED													
1½ 48,3	9.00 228,6	21.00 533,4	13.00 330,2	18.00 457,0	13.00 330,2	10.00 254,0	7.00 177,8	4.00 101,6	4.00 101,6	—	16.7 7,6	—	43.0 19,5
2 60,3	9.00 228,6	21.00 533,4	13.00 330,2	18.00 457,0	13.00 330,2	10.00 254,0	7.00 177,8	4.00 101,6	4.00 101,6	—	17.0 7,7	—	43.0 19,5
2½ 73,0	12.50 317,5	21.00 533,4	14.00 355,6	20.00 508,0	15.50 393,7	11.50 292,1	7.50 190,5	5.00 127,0	5.00 127,0	—	41.2 18,7	—	65.0 29,5
76,1 mm	12.50 317,5	21.00 533,4	14.00 355,6	20.00 508,0	15.50 393,7	11.50 292,1	7.50 190,5	5.00 127,0	5.00 127,0	—	41.2 18,7	—	65.0 29,5
3 88,9	12.50 317,5	21.00 533,4	14.00 355,6	20.00 508,0	15.50 393,7	11.50 292,1	7.50 190,5	5.00 127,0	5.00 127,0	—	42.1 19,1	—	65.0 29,5
4 114,3	15.00 381,0	20.00 508,0	15.00 381,0	21.00 533,4	14.00 355,6	12.00 304,8	8.00 203,2	9.00 228,6	6.00 152,4	—	55.0 24,9	—	95.0 43,1
6 168,3	16.00 406,4	21.10 535,9	16.00 406,4	22.00 558,8	14.00 355,6	12.00 304,8	8.50 215,9	7.00 177,8	7.00 177,8	—	73.0 33,1	—	115.0 52,2
165,1 mm	16.00 406,4	21.10 535,9	16.00 406,4	22.00 558,8	14.00 355,6	12.00 304,8	8.50 215,9	7.00 177,8	7.00 177,8	—	73.0 33,1	—	115.0 52,2
8 219,1	18.00 457,0	17.50 444,5	16.00 406,4	23.00 584,0	16.00 406,4	12.00 304,8	14.00 355,6	9.50 241,3	7.00 177,8	—	142.0 64,4	—	182.0 82,6
GROOVED X FLANGED													
4 114,3	16.00 406,4	20.00 508,0	15.00 381,0	21.00 533,4	14.00 355,6	12.00 304,8	8.00 203,2	9.00 228,6	6.00 152,4	65.0 29,5	—	105.0 47,6	—
6 168,3	17.00 431,8	21.10 535,9	16.00 406,4	22.00 558,8	14.00 355,6	12.00 304,8	8.50 215,9	7.00 177,8	7.00 177,8	83.0 37,6	—	125.0 56,7	—
165,1 mm	17.00 431,8	21.10 535,9	16.00 406,4	22.00 558,8	14.00 355,6	12.00 304,8	8.50 215,9	7.00 177,8	7.00 177,8	83.0 37,6	—	125.0 56,7	—
8 219,1	19.30 490,2	18.00 457,0	16.00 406,4	23.00 584,0	16.00 406,4	12.00 304,8	14.00 355,6	9.50 241,3	7.00 177,8	155.0 70,3	—	195.0 88,5	—

AIR MAINTENANCE TRIM

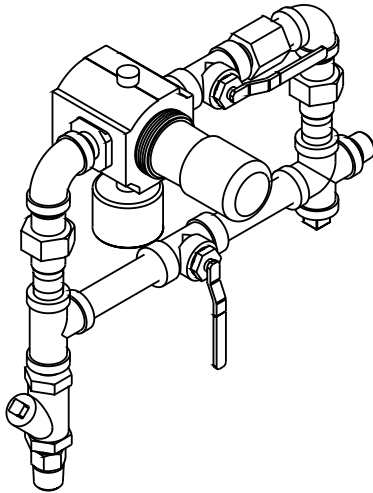

NOTES:

- 1) You must use an air regulator with Series 758 Preaction Valves that utilize an accelerator.
- 2) The recommended air pressures shown on the chart apply to valves utilizing a Series 753-A Dry Actuator. These pressures involve an 8 to 1 water-to-air ratio, plus a ten-pound safety factor.
- 3) If you install systems with multiple, pneumatic-actuated valves, isolate the systems by using a spring-loaded, soft seat check valve to ensure air integrity to each system.

Proper Air Supplies for Series 758 Preaction Valves:

1. When a riser or base-mounted air compressor supplies air to a system utilizing a Series 753-A Dry Actuator, it is not necessary to use the air maintenance trim assembly with the air regulator. In this circumstance, the airline of the compressor connects to the valve's trim at the fitting where the air maintenance trim is normally installed.

When the valve is used with this setup, it is the engineer's/system designer's

responsibility to size the compressor so that it brings the entire system to the required pressure within 30 minutes. The engineer/system designer must not oversize the compressor to provide more airflow because it will slow down, or possibly prevent, the operation of the valve. Furthermore, a base-mounted compressor does not provide any backup air to the system. Therefore, the system requires continuous service (24 hours per day, 7 days per week) in order to prevent the valve from false tripping due to a loss of air pressure.

Due to the large on/off differential available on pressure switches that control base-mounted compressors, you must adjust the compressor pressure switch so that the "ON" contact of the pressure switch is at the recommended air supply for the valve.

2. When shop air or a tank-mounted air compressor is used, you must use Victaulic Company's Air Maintenance Trim Assembly (AMTA). The AMTA provides the proper air regulation to the sprinkler system, which will ensure the

proper operation of the fire safety valve.

3. When a Series 746 Dry Accelerator is used in conjunction with the Series 753-A Dry Actuator, you must use the AMTA with the air regulator.

In the event that a compressor becomes inoperative, the tank-mounted air compressor provides the greatest protection. With a properly sized tank, air can be supplied continuously to the sprinkler system for an extended time, even without an operating compressor.

RECOMMENDED AIR PRESSURE FOR DRY AND PNEUMATIC ACTUATED SYSTEMS

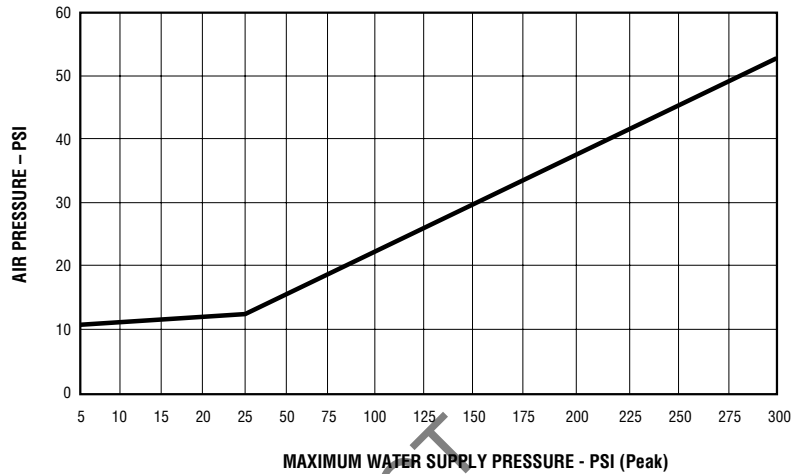

COMPRESSOR REQUIREMENTS

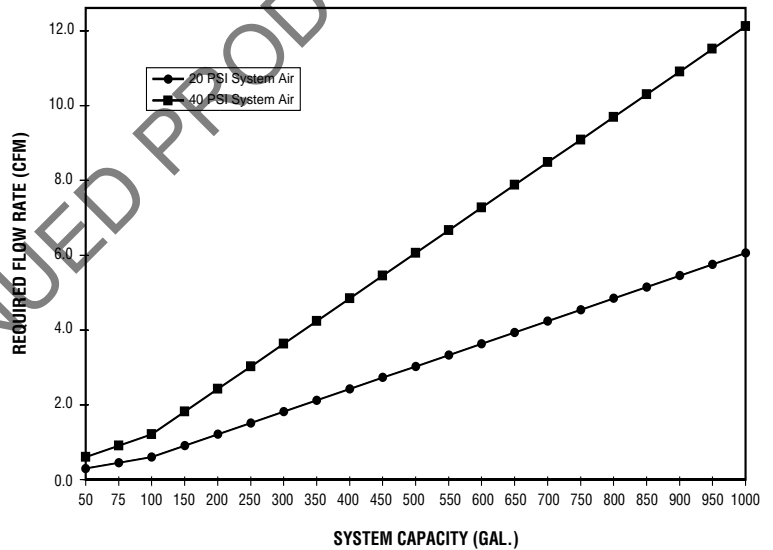

INSTALLATION

For proper operation and approval, you must install the valve in accordance with the trim diagrams for the Series 758 Preaction Valve. Victaulic provides specific trim drawings for all release installations.

NOTE: The Series 753-A Dry Actuator **CANNOT** be used on double-interlock pneumatic/electric or pneumatic/pneumatic setups. These systems require a 758-LPA system.

The Series 758 Preaction Valve must **NOT** be located in an area that is subject to freezing temperatures. In addition, the valve must **NOT** be located in an area where physical damage may occur. It is the owner's responsibility to confirm material compatibility of the Series 758 Preaction Valve, trim, and associated accessories when a corrosive atmosphere or contaminated water is present.

Air or nitrogen supply to the Preaction piping system must be clean, dry, and oil free. Automatic air supplies must be regulated, restricted, and continuous. Victaulic recommends the installation of an air maintenance device on any system with an automatic air supply.

When used with a water motor alarm, configure the valve with an uninterrupted, low-pressure alarm mounted to the valve's piston.

NOTE: You do not need to add a check valve to the riser above the preaction valve. The clapper is not subject to water columning and, in addition, the preaction valve itself acts as a spring-loaded check valve after it trips.

Prior to installing the valve, flush the water supply piping thoroughly in order to ensure that no foreign objects are present.

Install the Series 758 Preaction Valve in the vertical position with the arrow on the body pointing upward.

1. Confirm that all required drawings and data for the installation of the valve are available.
2. Remove all plastic caps from the valve.

⚠ WARNING	
	<ul style="list-style-type: none">• Valves are shipped with a cardboard spacer holding the clapper shut. This spacer MUST be removed BEFORE installation of the valve. <p>Failure to follow this instruction could result in serious personal injury, property damage, valve leakage, and/or valve failure.</p>

3. For valves 3" (88,9 mm) or smaller, it is necessary to remove the piston assembly when trimming the valve.

- 3a. Unscrew the piston from the valve's body.
- 3b. Note the position of the o-ring. This o-ring must be in the same position when you reassemble the piston.
- 3c. Install the trim to the back of the valve.

3d. Reassemble the piston, making sure that the o-ring is positioned properly and that the piston rod and the latch engage properly. It may be necessary to rotate the latch inward (toward the valve body's center) to ensure proper alignment.

3e. Tighten the piston until you achieve metal to metal contact with the valve body.

⚠ WARNING	
	<ul style="list-style-type: none">• Make sure you reassemble and install the piston correctly according to the instructions contained in this manual. <p>Failure to follow these instructions could result in serious personal injury, valve malfunctioning, and/or property damage.</p>

4. Apply a small amount of pipe joint compound or Teflon* pipe tape to the external threads of all threaded pipe connections. Be careful not to get any tape, compound, or other foreign substances into the valve or the inside of any nipples or valve openings.

5. Make sure that the trim drawing matches the system's requirements. Install the Victaulic Series 758 Actuated Valve in accordance with the applicable trim drawings.

6. Provide an uninterrupted source of water from upstream of the main control valve to supply pressure to the piston charge line before opening the main control valve.

IMPORTANT SETTINGS

Pneumatic Release Systems

1. Supply a minimum air pressure, determined from the chart on page 6, for pneumatic release systems.
2. Set the air supervisory switch to activate at 5 psi (34 kPa) below the minimum air pressure required.
3. Wire the air supervisory switch to activate a low pressure alarm signal. A high pressure alarm may also be required by the authority having jurisdiction.

Electric Release Systems

1. Apply the minimum amount of air for proper supervision, depending on the type of supervisory switch you are using.

Alarm Pressure Switch

1. Set the alarm pressure switch to activate on a pressure rise of 4 - 8 psi (25 - 55 kPa). Wire the alarm pressure switch to activate a water flow alarm.

Air Supply Design

1. Size the air supply system to establish the required air pressure in the system within 30 minutes. The air supply must be regulated, restricted, and maintained automatically.

⚠ WARNING	
	<ul style="list-style-type: none">• Properly size and build the air supply system. <p>Failure to follow this instruction could result in serious personal injury, property damage, and/or valve leakage.</p>

*Teflon is a registered trademark of I.E. Dupont de Nemours.

2. Regulate the air pressure to the proper system air pressure. Air pressure differing from the required system air pressure could affect the operation of the system adversely.

3. Restrict the air supply in order to ensure that air being exhausted from an open head or manual release valve is not replaced by the air supply system as fast as it is being exhausted.

4. It is recommended practice that an inspector's test connection be provided on the release system. This inspector's test connection should be equipped with a ball valve (normally locked closed), which can be opened in order to simulate the actuation of a release device. Locate the test connection at the highest, most hydraulically demanding location in the release system. The test connection should terminate with an orifice equal to the smallest orifice in the releasing system. The inspectors test connection can be used in order to confirm that the air or water supply systems are not supplying pressure at a rate faster than the releasing device can exhaust pressure.

PLACING THE SYSTEM IN SERVICE

When the preaction system is ready to be placed in service, verify that all equipment is heated and protected properly from freezing temperatures and physical damage.

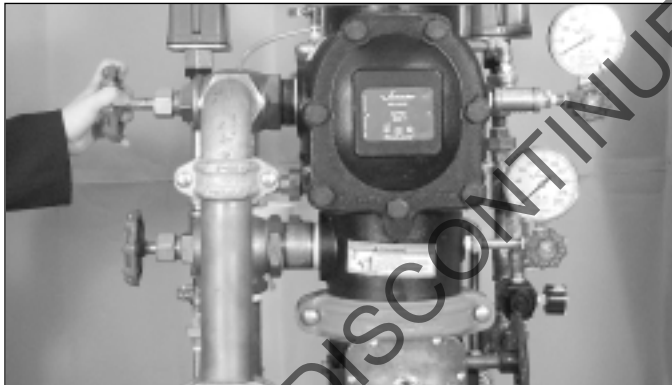

1. Open the system main drain valve located above the clapper. Confirm that the system is drained.

2. Close the system main drain valve.

3. Confirm that the system drains are shut and that the system is free of leaks.

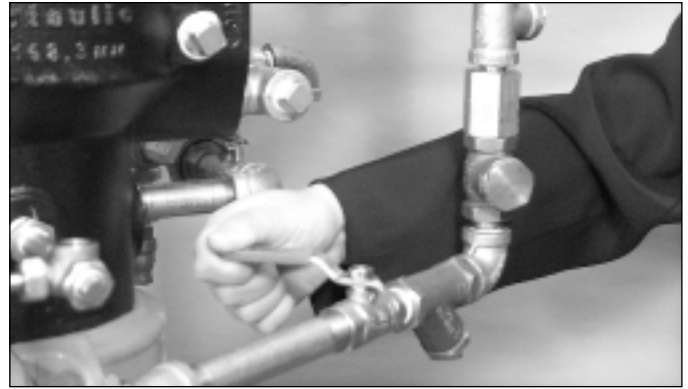

4. For electric release systems: Open the piston charge line ball valve. Make sure that no water flows from the solenoid.

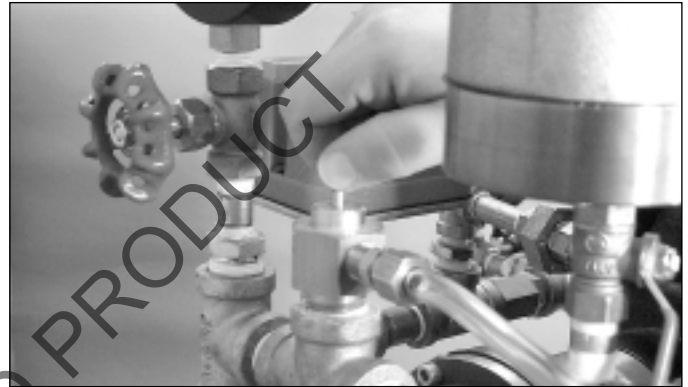

4a. Remove the red protective cap from the Series 749 Auto Drain. Pull up on the auto drain set screw until the auto drain is set (approximately 10 psi/69 kPa). Replace the protective cap on the auto drain.

⚠ WARNING

- Make sure you always replace the protective cap over the auto drain set screw of the Series 749 to avoid accidental contact. Hitting the set screw will cause the valve to trip.

Failure to follow this instruction could result in serious personal injury, and/or property damage.

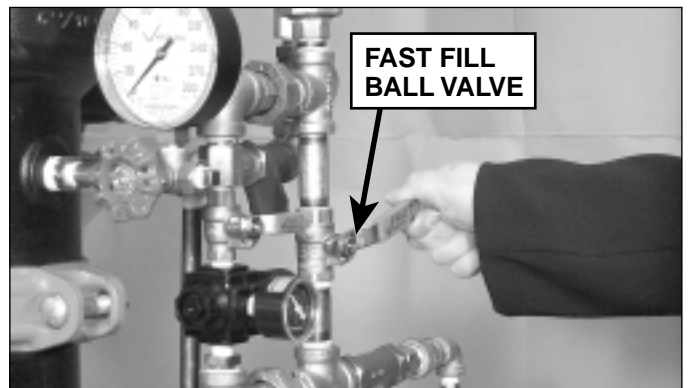

5. For pneumatic systems: Open the fast fill ball valve on the air maintenance device. Fill the system to the appropriate air pressure for the typical water supply pressure in the area.

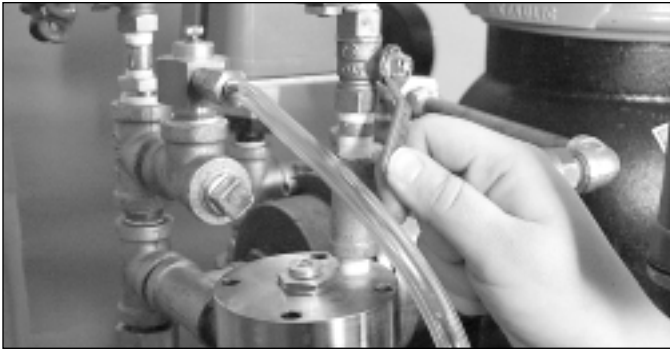

5a. If the system contains a Series 746 Dry Accelerator, close the 1/4-inch isolation ball valve.



5b. Confirm that the system is charging by observing the air pressure gauge. If the gauge is not showing an increase in air pressure, there is a leak or an open line in the release system. It may be necessary to push down on the upper chamber seal of the Series 753-A Dry Actuator while the system is charging.

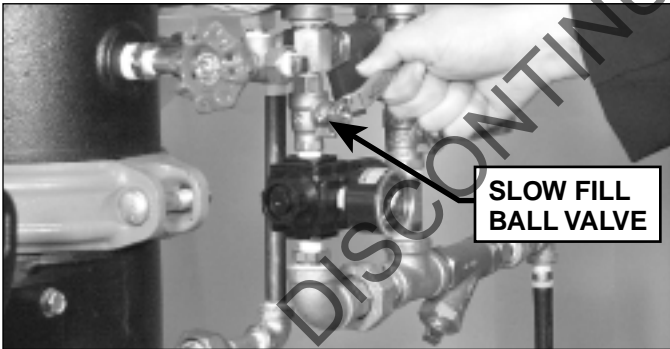

6. Once the system's air pressure has been established, close the fast fill ball valve. Open the slow fill ball valve. Confirm that the air regulator is set to the proper system pressure. **NOTE:** On systems using a Series 746 Accelerator, set the accelerator by following the instructions provided with the accelerator (I-746).

6a. Observe the system's air pressure over a 24 hour period to confirm system integrity. If there is degradation in the system air pressure, find the leaks and correct. NFPA requires less than 2 psi leakage in 24 hours.

6b. For electric systems: Confirm that the solenoid is closed.

6c. For valves equipped with an accelerator: The accelerator **must** be set prior to setting up the water supply (refer to the accelerator's installation manual I-746).

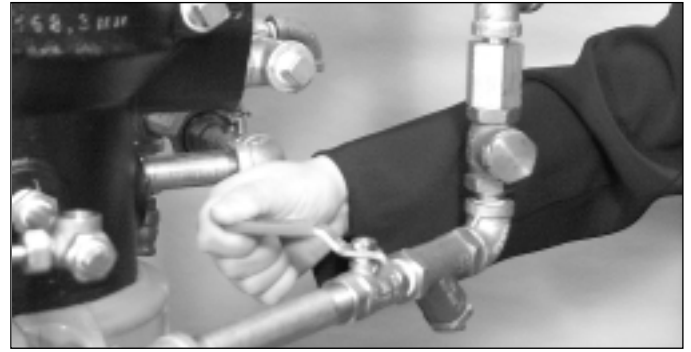

7. Open the piston charge line ball valve. Allow the system to pressurize.



8. Remove the red protective cap from the Series 749 Auto Drain. Pull on the auto drain set screw until the auto drain is set (approximately 10 psi). Replace the protective cap on the auto drain.

⚠ WARNING

- Make sure you replace the protective cap over the auto drain set screw to avoid accidental contact. Hitting the set screw will cause the valve to trip. Failure to do so could result in serious personal injury and/or property damage.

SERIES 749 AUTO DRAIN ASSEMBLY

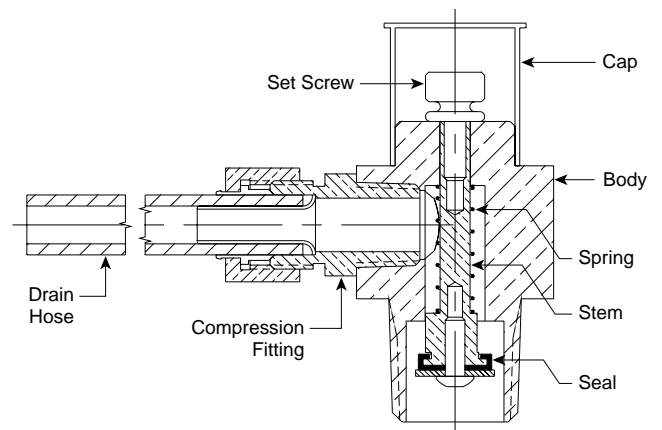

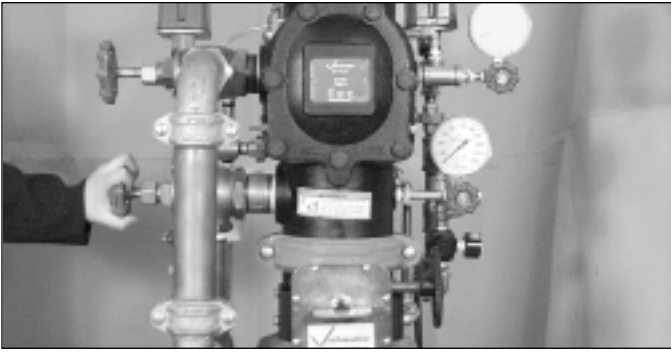

9. Open the water supply main drain valve. This is the drain located below the clapper.

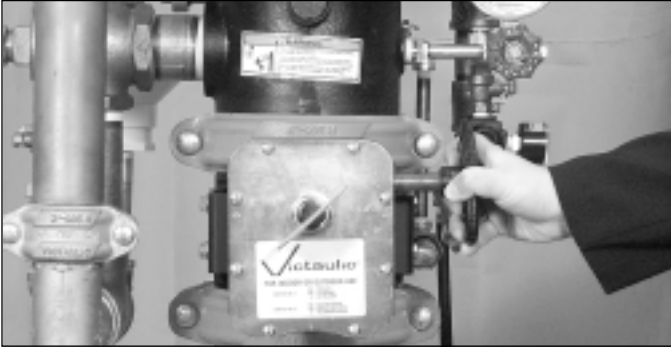

10. Open the main water supply control valve slowly until a steady flow of water is flowing from the open water supply drain valve.

⚠ CAUTION

- Opening the main control valve of the water supply will cause water to flow from all open system openings.
Doing so may cause personal injury or property damage.

11. Once a steady flow of water occurs, close the main water supply drain valve slowly. Confirm that there is no leakage from the ball drip, located in the alarm line's piping. If water is flowing from the ball drip, close the main water supply control valve and start over at step 1.



- 12.** Fully open the main water supply control valve.
- 13.** Record the system air pressure and the water supply pressures.
- 14.** Secure all valves in their normal operating positions.
- 15.** Notify the authority having jurisdiction, remote station monitors, and those in the affected area that the system is in service.

SETTING UP THE SERIES 746 DRY ACCELERATOR



Refer to the installation and assembly instructions for the Series 746 Dry Accelerator (I-746) to set up the accelerator.

DISCONTINUED PRODUCT

INSPECTION AND TESTS

⚠ WARNING

The owner is responsible for maintaining the preaction system in proper operating condition.

- It is important that you inspect and test this preaction system regularly, according to proper procedures.
- The Victaulic Series 758 Preaction Valve and trim must not be exposed to foreign matter, corrosive atmospheres, freezing conditions, contaminated water supplies, or any other condition that could impair the proper operation of the system.
- You must modify the frequency of inspections in the presence of any environmental conditions that could degrade the system's operation.
- The National Fire Protection Association Pamphlet, which describes the care and maintenance of sprinkler systems, outlines the minimum requirements for tests and inspections.
- In addition, the authority having jurisdiction may have maintenance, inspection, and test requirements that must be followed.

Failure to follow these instructions may result in serious personal injury, property damage, and/or system failure.

⚠ WARNING



- Any service that requires taking the system out of service may eliminate the fire protection provided by the system. Prior to servicing or testing the system, notify the authority having jurisdiction of the operation being performed. Consideration of a fire patrol should be given in the affected areas.

Failure to do so could result in serious personal injury, and/or property damage.

WEEKLY INSPECTION

It is recommended that a visual inspection be performed on the preaction system and trim on a weekly basis. If the preaction system is equipped with a low pressure alarm, monthly inspections may be sufficient.

1. Record the system pressures. Confirm that the water supply pressure is in the range of normal pressures observed in the area. Significant loss in supply pressure could indicate an adverse condition in the water supply. Confirm that the proper air-to-water pressure ratio is being maintained.
2. Confirm that there is no leakage from the intermediate chamber of the valve. No water should flow from the ball drip. Refer to the troubleshooting section.
3. Check for mechanical damage or corrosion. If found, perform maintenance on the affected parts.
4. Confirm that the valve and trim are not subject to freezing conditions.
5. Verify that all system valves are in their normal operating positions.
6. If the preaction system is equipped with the Series 746 Accelerator, record the pressure in the upper chamber of the accelerator. This pressure should equal the system air pressure within the allowable tolerances of the gauges. If the upper chamber air pressure is below the system air pressure, follow the troubleshooting procedure for the accelerator.

REQUIRED TESTS

Main Drain Test

Perform the main drain test on a frequency required by the current NFPA-25 code. The authority having jurisdiction in your area may require that you perform these tests on a more frequent basis. Verify these requirements by contacting the authority having jurisdiction in your affected area.

1. Inform the authority having jurisdiction, remote station alarm monitors, and anyone in the affected area that the test will be performed.
2. Perform and record the monthly visual inspection.
3. Confirm that you have sufficient drainage for a full flow drain test.
4. Record the water supply pressure and the pilot system air pressure.
5. Verify that the intermediate chamber of the preaction system is dry. No water should flow from the ball drip.
6. **For pneumatic systems:** Verify that the preaction system and pilot line are pressurized at the proper air pressure for the local water supply pressures.



7. Open the water supply main drain valve fully.

⚠ CAUTION

- Be careful not to open the system main drain accidentally. Opening the system main drain will cause the system to operate, which may result in property damage.

8. With the water supply drain valve fully open, record the water supply pressure. Record this as the residual pressure.
9. Close the water supply main drain valve slowly.
10. Compare the residual pressure reading taken above to the residual pressure readings taken in previous main drain tests. If there is a degradation in the residual water supply readings, take the appropriate measures to restore proper water supply pressure.
11. Record the water pressures established after closing the main drain. Confirm that all ball valves are in their proper positions.
12. Notify the authority having jurisdiction, remote station alarm monitors, and those in the affected area that the valve has been placed back in service. Provide test results to the authority having jurisdiction, if required.

Water Flow Alarm Test

Perform the water flow alarm test on a frequency required by the current NFPA-25 code. The authority having jurisdiction in your area may require that you perform these tests on a more frequent basis. Verify these requirements by contacting the authority having jurisdiction in your affected area.

1. Notify the authority having jurisdiction and those in the affected test area that a test is in progress.



2. Open the water supply main drain fully and flush the water supply of any contaminants.

3. Close the water supply main drain valve.

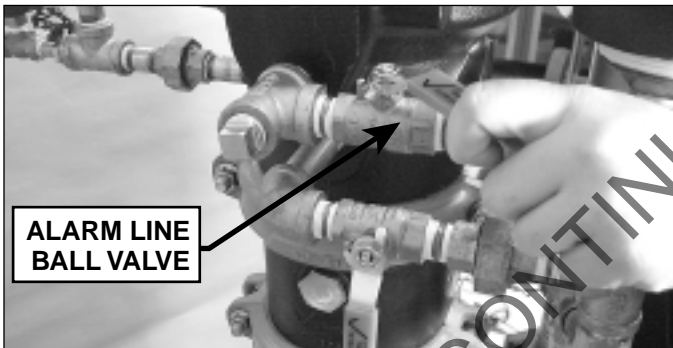

Note: Photo taken of alarm valve for clarity of ball valve's location.

4. Close the alarm line ball valve.

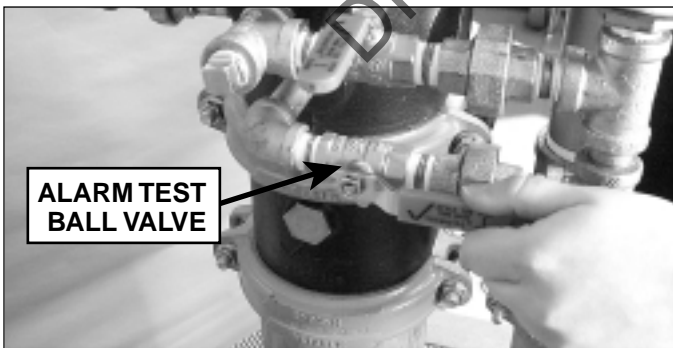

Note: Photo taken of alarm valve for clarity of ball valve's location.

4a. Open the alarm test ball valve in the preaction system's trim. Confirm that mechanical and electric alarms provided are activated and that remote monitoring stations, if provided, receive an alarm signal.

5. After ensuring proper operation of all alarms, close the alarm test ball valve and open the alarm drain ball valve, located in the trim below the alarm test ball valve. Verify that all alarms stop sounding, that the water motor alarm has drained properly, and that remote station alarms reset properly.

6. Confirm that the alarm test ball valve is closed. Close the alarm drain ball valve. Open the alarm line ball valve.

7. Verify that the intermediate chamber of the preaction system is dry. No water should flow from the ball drip.

8. Notify the authority having jurisdiction, remote station alarm monitors, and those in the affected area that the valve has been placed back in service.

Water Level and Low Air Alarm Test

Perform the water level and low air alarm tests on a frequency required by the current NFPA-25 code. The authority having jurisdiction in your area may require that you perform these tests on a more frequent basis. Verify these requirements by contacting the authority having jurisdiction in your affected area.

1. Notify the authority having jurisdiction and those in the affected area that the test will be in progress.

NOTICE

- Be sure to notify the authority having jurisdiction that a test is in progress. Closing the isolation ball valve of the Series 746 Accelerator may cause the valve to trip, resulting in a false alarm.



2. If the valve is equipped with a Series 746 Dry Accelerator, close the 1/2-inch isolation ball valve.



3. Open the water supply main drain valve to flush any contaminants that may have collected.

4. Close the main water supply control valve.
5. Open the inspector's test valve. Record the system air pressure at which the low air alarm activates.
6. Close the inspector's test valve.
7. Perform Steps 4 - 14 of the "Placing the System in Service" section.

TRIP TEST

Partial flow tests are used to confirm the proper operation of the valve. The partial flow test does not confirm the operation of the full system.

Full flow testing allows the full flow of water into the sprinkler system and must be done in warm weather when there is no chance of freezing conditions.

The frequency of inspections may vary due to environmental conditions. For minimum maintenance and inspection requirements, refer to the NFPA pamphlet describing the care and maintenance of sprinkler systems. More frequent full and partial flow tests may be required by the authority having jurisdiction.

Partial Flow Test

1. Notify the authority having jurisdiction and those in the affected area that the test will be in progress.
2. Record the water supply pressure and the system air pressure.



3. Fully open the water supply main drain valve to flush any foreign materials from the system.

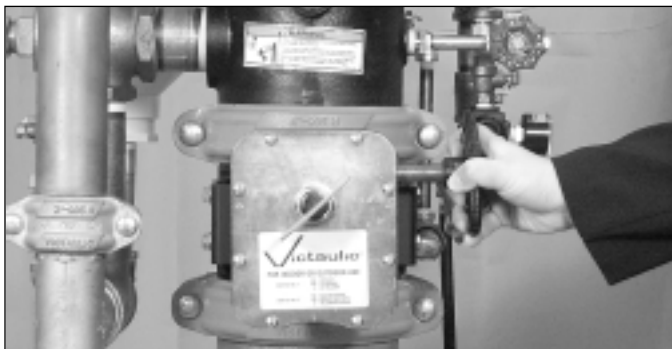

4. Close the main water supply control valve.

5. Slowly open the main water supply control valve until a small flow of water is detected from the water supply main drain.

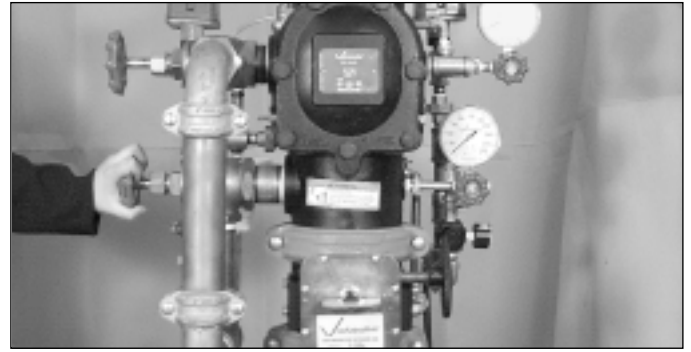

6. Close the water supply drain valve.

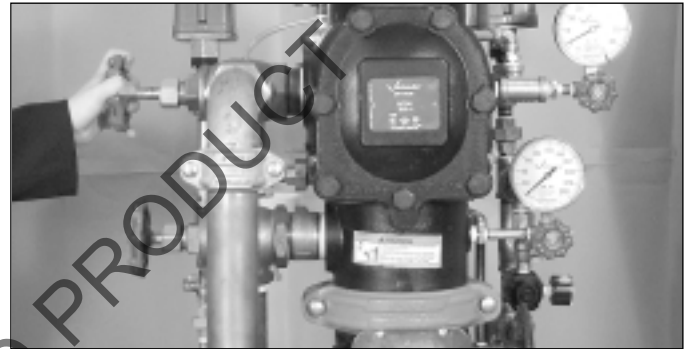

7. Open the system main drain. **NOTE:** In a pneumatic system, this may trip the valves.

8. Open the inspector's test connection to simulate an open sprinkler head.

9. Record the system air pressure when the valve activates. When the valve activates, water will be expelled from the ball drip and the dry actuator.

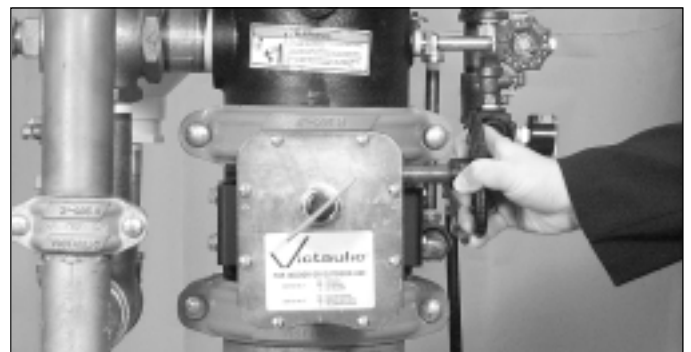

10. Close the main water supply control valve.

11. Follow Steps 4 - 10 of the "Placing the System in Service" section.

Full Flow Test

⚠ WARNING



• Any system service that requires taking the system out of service may eliminate the fire protection provided by the system. Prior to servicing or testing the system, notify the authority having jurisdiction of the operation being performed. Consideration of a fire patrol should be given in the affected areas.

Failure to do so could result in serious personal injury and/or property damage.

1. Notify the authority having jurisdiction and those in the affected area that the test will be in progress.
2. Record the water supply pressure and the system air pressure.



3. Fully open the water supply main drain valve to flush any foreign materials from the system.
4. Close the water supply main drain valve.
5. Open the inspector's test valve to simulate the operation of a sprinkler head. For certain systems, it may be necessary to trip the emergency release.
6. Confirm that all alarms operate properly.
7. Continue to run water until the water runs clear.
8. Close the remote test connection.



9. Close the main water supply control valve.
10. Follow Steps 4 - 10 of the "Placing the System in Service" section.

MAINTENANCE

⚠ WARNING



• Piping systems must always be depressurized and drained before attempting disassembly and removal of any Victaulic piping products.

Failure to follow this instruction could result in serious personal injury, property damage, and/or valve leakage.

⚠ WARNING



• Any system service that requires taking the system out of service may eliminate the fire protection provided by the system. Prior to servicing or testing the system, notify the authority having jurisdiction of the operation being performed. Consideration of a fire patrol should be given in the affected areas.

Failure to do so could result in serious personal injury and/or property damage.

1. Notify the authority having jurisdiction and those in the affected area that the system will be taken out of service.

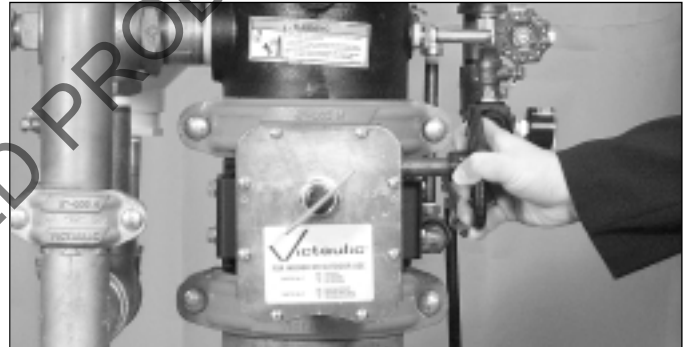

2. Close the main water supply control valve. This takes the system out of service.



3. Open the water supply main drain valve.
4. Confirm that no water is flowing from the water supply main drain.

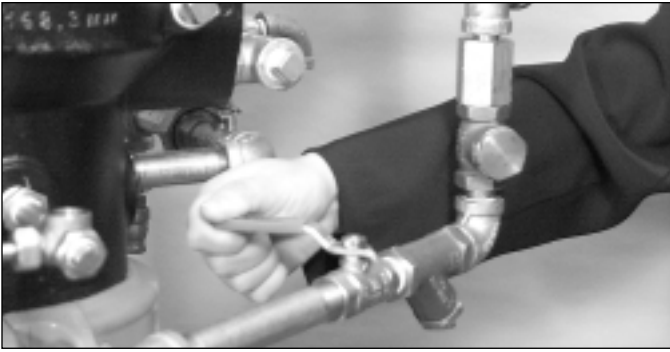

5. Close the piston charge line ball valve.



6. Open the system main drain valve. This drains the system of any water that has accumulated. If the system has operated, open the remote test valve and any auxiliary drain valves in the system.

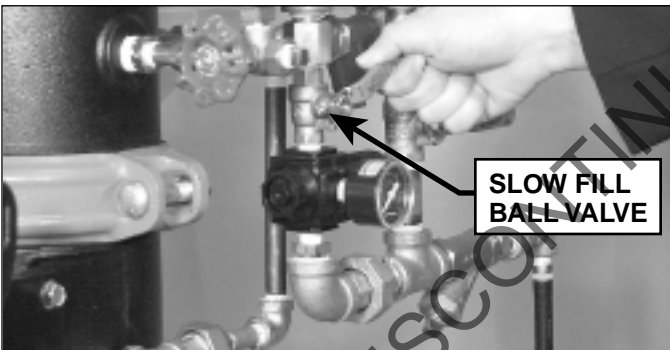

7. Close the slow fill ball valve on the air maintenance system.



8. After pressure has been released, loosen the valve's cover bolts. Remove the valve's cover, or allow the cover to pivot on one of the lower bolts.

⚠ WARNING



- **ALWAYS DEPRESSURIZE THE VALVE BEFORE REMOVING COVER PLATE BOLTS.** The valve must be depressurized before removing these bolts. The cover will blow off if these bolts are removed while the valve is pressurized.

Failure to follow this instruction may result in property damage or serious personal injury.

⚠ WARNING

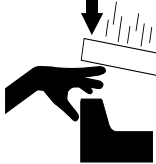

- If water is coming from the weep hole under the valve cover, **THE WATER SUPPLY VALVE IS NOT CLOSED! CLOSE THE WATER SUPPLY VALVE NOW!**
- Use caution when closing the water supply valve. The clapper could trip and pinch fingers.

Failure to do so could result in serious personal injury or property damage.

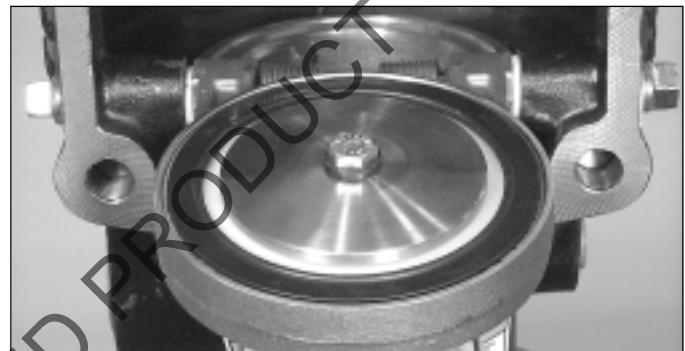

9. Rotate the clapper out of the access area and inspect both the rubber clapper facing and the brass seat ring in the body. Wipe away any contaminants, dirt, and mineral deposits. Clean any holes in the seat ring that may be plugged or restricted. **DO NOT USE SOLVENTS OR ABRASIVES.**

⚠ CAUTION

- The use of solvents or abrasives on or near the seat ring may diminish the ability of the valve to seal properly.

Failure to do so could result in improper operation or property damage.



10. Inspect the clapper for freedom of movement and physical damage. Replace any damaged or worn parts.

11. Following inspection of the valve, follow the steps in the "Placing the System in Service" section on page 8.

REMOVING THE RUBBER CLAPPER FACING



1. Remove the single bolt/washer from the clapper face.

CAUTION

- This is a self sealing bolt/washer, it is critical that you use a new, Victaulic-supplied replacement when you reassemble the clapper. Failure to follow this instruction could result in significant property damage.

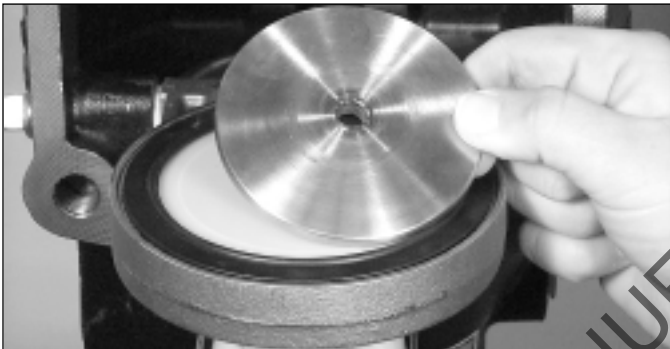

2. Remove the brass retaining ring.



3. Remove the plastic seal-retaining ring from the inside of the rubber seal.



4. Pry the clapper's seal, along with the outer seal-retaining ring, out of the clapper. Inspect the seal. If the seal is torn, or if it shows any signs of wear, replace the seal.

INSTALLING THE RUBBER CLAPPER SEAL

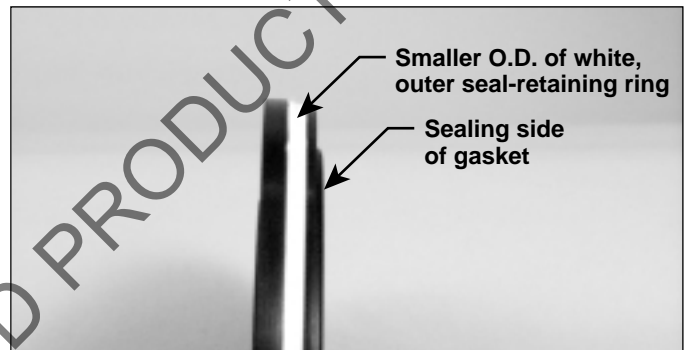

1. If you removed the outer seal-retaining ring from the seal in step 4, re-insert the outer seal-retaining ring carefully underneath the outer lip of the gasket. Make sure the smaller OD of the outer seal-retaining ring is toward the sealing surface of the gasket.



2. Insert the inner seal-retaining ring carefully underneath the sealing lip of the gasket.

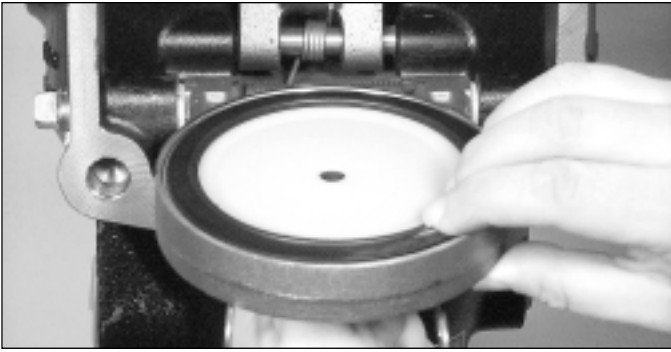

3. Ensure that the clapper is free of contaminants, dirt, and mineral deposits.

3a. Carefully put the rubber seal into the clapper so that the clapper retains the outer edge of the seal. Make sure that the seal is pushed all the way down in the clapper and that the outer seal-retaining ring snaps into position.



4. Place the brass retaining ring onto the seal and bolt the retaining ring to the clapper with the bolt/washer provided. Tighten the bolt/washer sufficiently, and apply an additional 1/2 turn to ensure a proper seal.

REMOVING THE CLAPPER ASSEMBLY



1. Remove the shaft retaining plugs from the valve body.

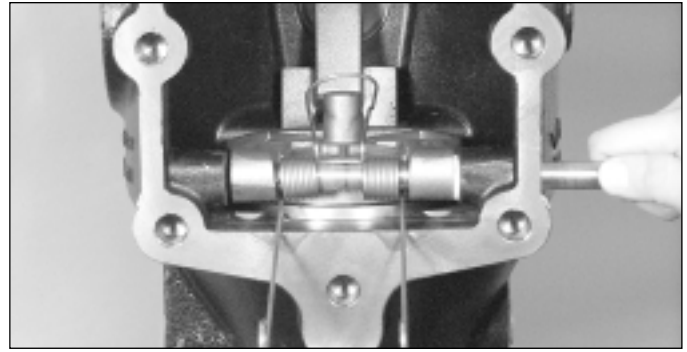

2. Slide the clapper's shaft through the body and the clapper.

3. Remove the clapper.

INSTALLING THE CLAPPER

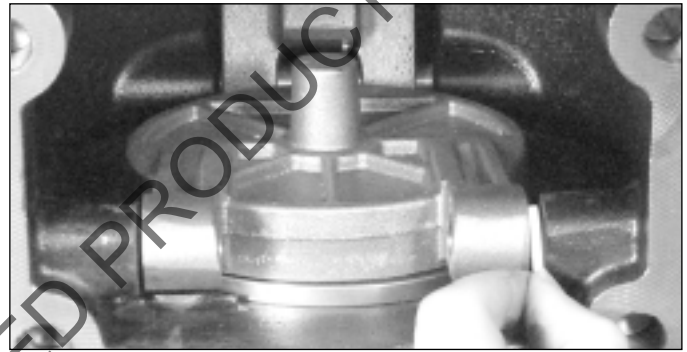

1. Place the clapper on the seat ring so that the clapper shaft can pass through both the body and the clapper. Make sure one spacer/washer is placed on the outside of each clapper arm.

2. Position the clapper spring so that the loop is on the clapper and the spring coils are inside the clapper arms. Proper positioning will allow the clapper's shaft to pass through the spring coils.

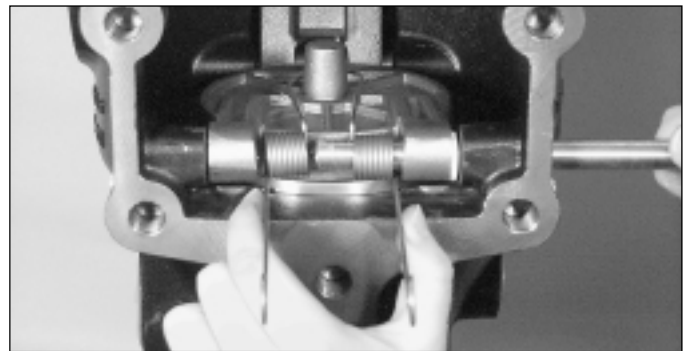

3. Slide the shaft through the body into the first clapper arm, then through the clapper spring coils then out the other clapper arm and into the body.v

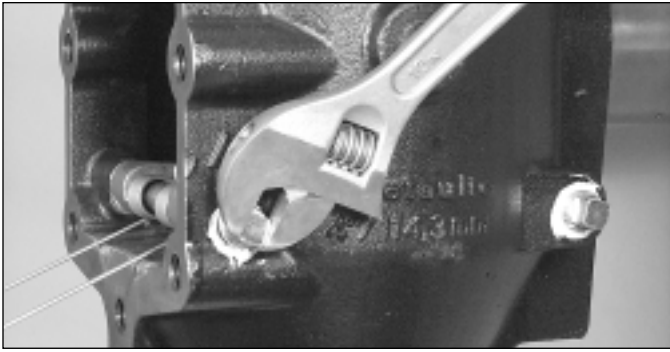

4. Screw the shaft retaining plugs back into the body.

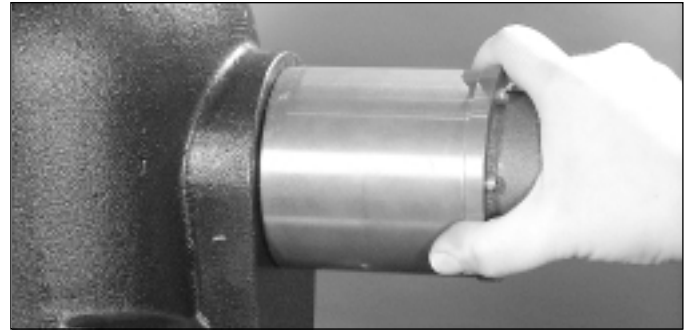

5. Attach the trim as per the trim drawings.

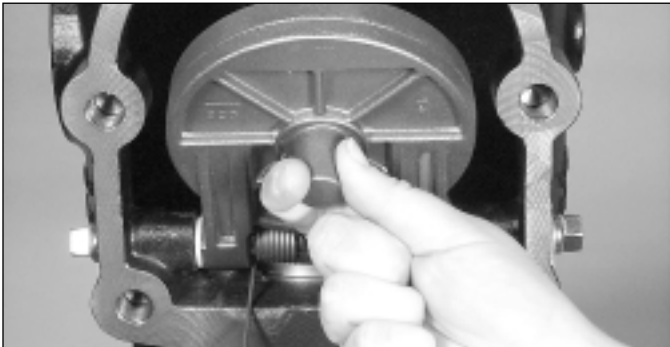

5. Confirm the free movement of the clapper prior to assembling the valve.

REMOVING THE ACTUATOR PISTON

1. Disconnect the trim from the piston.



2. Unscrew the piston from the valve body.

3. Repair or replace the piston assembly.

⚠ WARNING

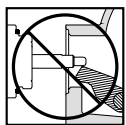

• Make sure you reassemble and install the piston correctly according to the instructions contained in this manual. Failure to follow these instructions could result in serious personal injury, valve malfunctioning, and/or property damage.

4. Screw the piston into the valve body.

INSTALLING THE COVER PLATE

1. Verify that the cover gasket is in good condition; if not, replace the gasket. Align the cover plate gasket with the holes on the cover plate. Insert one bolt through the cover plate and cover gasket.



2. Align the cover plate and cover gasket to the valve. Ensure that the spring arms are now rotated to their installed position. Insert the bolts by hand.



3. Tighten all bolts using an alternate and even pattern. Tighten the bolts to the proper torque per the chart below. Do not over-tighten or under-tighten these bolts.

Recommended Cover Bolt Torque

Size (Inches)	Torque (Ft. Lbs.)	Size (Inches)	Torque (Ft. Lbs.)	Size (Inches)	Torque (Ft. Lbs.)
1½	30	76,1 mm	60	6	115
2	30	3	60	165,1 mm	115
2½	60	4	100	8	100

Place the system back in service by following the "Placing the System in Service" section on page 8.

TROUBLESHOOTING – Series 753-A Dry Actuator

Problem	Possible Cause	Solution
The upper chamber seal does not engage when pushing down on it during system setup.	The adjustable seat on the top of the actuator is set too low.	Turn the seat with an adjustable wrench ¼ turn counterclockwise. Try to set the actuator again. If it still does not set, repeat this adjustment procedure until it does engage.
Water leaks through the actuator into the drain when the water supply line to the piston is opened.	The adjustable seat on the top of the actuator is set too high.	Close the ball valve on the piston water supply line. Open the system main drain until the Actuator trips. Turn the seat with an adjustable wrench ¼ turn clockwise. Set the actuator again. If it still leaks, repeat the above procedure until it doesn't leak.

TROUBLESHOOTING – Series 746 Dry Accelerator

Problem	Possible Cause	Solution
The system valve operates without sprinkler activation.	Loss of air pressure in the lower inlet chamber.	Check for any leaks in the system and the trim. Confirm the proper operation of the air maintenance device attached to the trim.
The dry accelerator does not operate within a 5-psi pressure drop in the system's air pressure.	Loss of air pressure in the upper air chamber of the dry accelerator.	Apply soapy water to all dry accelerator joints and check for air leaks. Repair all leaks and re-test.

TROUBLESHOOTING – System

Problem	Possible Cause	Solution
Valve actuates when no sprinkler activation has occurred.	Loss of air pressure in system.	Check for system leaks. Confirm the proper operation of the air maintenance device attached to the system. Consider installing a low air pressure alarm.
Water leaking from the ball drip.	Water is getting past the seal into the intermediate chamber.	Check the clapper rubber seal and the valve seat ring for physical damage or the presence of a foreign object in the seal surface.
Clapper will not latch closed.	No air pressure on the dry actuator. No water pressure on the actuator piston.	Confirm that the ball valve is open on pneumatic/pneumatic systems and that the pressures in the pilot line and system line are greater than 8 psi.

WARRANTY

We warrant all products to be free from defects in materials and workmanship under normal conditions of use and service. Our obligation under this warranty is limited to repairing or replacing at our option at our factory any product which shall within one year after delivery to original buyer be returned with transportation charges prepaid, and which our examination shall show to our satisfaction to have been defective.

THIS WARRANTY IS MADE EXPRESSLY IN LIEU OF ANY OTHER WARRANTIES, EXPRESS OR IMPLIED, INCLUDING ANY IMPLIED WARRANTY OF MERCHANTABILITY OR FITNESS FOR A PARTICULAR PURPOSE. THE BUYER'S SOLE AND EXCLUSIVE REMEDY SHALL BE FOR THE REPAIR OR REPLACEMENT OF DEFECTIVE PRODUCTS AS PROVIDED HEREIN. THE BUYER AGREES THAT NO OTHER REMEDY (INCLUDING, BUT NOT LIMITED TO, INCIDENTAL OR CONSEQUENTIAL DAMAGES FOR LOST PROFITS, LOST SALES, INJURY TO PERSON OR PROPERTY OR ANY OTHER INCIDENTAL OR CONSEQUENTIAL LOSS) SHALL BE AVAILABLE TO HIM.

Victaulic neither assumes nor authorizes any person to assume for it any other liability in connection with the sale of such products.

This warranty shall not apply to any product which has been subject to misuse, negligence or accident, which has been repaired or altered in any manner outside of Victaulic's factory or which has been used in a manner contrary to Victaulic's instructions or recommendations. Victaulic shall not be responsible for design errors due to inaccurate or incomplete information supplied by Buyer or its representatives.

EFFECTIVE OCTOBER 15, 1997



www.victaulic.com
e-mail: victaulic@victaulic.com

WORLD HEADQUARTERS
P.O. Box 31 • Easton, PA 18044-0031
4901 Kesslersville Road • Easton, PA, USA 18040
Phone: 610/559-3300 • FAX: 610/250-8817



CUSTOMER CARE CENTER
Phone: 1-800-PICK-VIC (1-800-742-5842) • e-mail: pickvic@victaulic.com

VICTAULIC COMPANY OF AMERICA
P.O. Box 31 • Easton, PA 18044-0031
Phone: 610/559-3300 • Fax: 610/250-8817

**Fire Protection Division
Customer Care Centers**

- **SOUTHEAST FIRE PROTECTION**
Phone: 877/773-8322 • Fax: 877/776-9769
- **NORTHEAST FIRE PROTECTION**
Phone: 888/265-0805 • Fax: 888/265-0918
- **CENTRAL FIRE PROTECTION**
Phone: 888/448-3534 • Fax: 888/448-3595
- **WESTERN FIRE PROTECTION**
Phone: 877/487-7231 • Fax: 877/487-7232

Victaulic Tool Company

P.O. Box 31 • Easton, PA 18044-0031
Phone: 610/559-3300 • Fax: 610/923-3090

Victaulic Municipal Division

1818 Vultee Street • Allentown, PA 18103
Phone: 610/559-3488 • Fax: 610/923-3170

Victaulic Technical Services Division

1818 Vultee Street • Allentown, PA 18103
Phone: 610/559-3488 • Fax: 610/923-3170

United States Distribution Centers

- **NORTHEAST**
7 Forge Parkway • Franklin, MA 02038
Cust.Care: 800/742-5842 • Cust. Fax: 888/265-0926
- **NEW YORK METRO**
4901 Kesslersville Road • Easton, PA 18040
Cust.Care: 800/742-5842 • Cust. Fax: 800/437-6573
- **SOUTHEAST**
650 Coastline Drive • Yulee, FL 32097
Cust.Care: 800/742-5842 • Cust. Fax: 888/201-3468
- **ATLANTIC**
166 Thorn Hill Road • Warrendale, PA 15086
Cust.Care: 800/742-5842 • Cust. Fax: 888/201-3517
- **MIDWEST**
730 Thomas Drive • Bensenville, IL 60106
Cust.Care: 800/742-5842 • Cust. Fax: 888/265-2018
- **GREAT LAKES**
23107 Commerce Drive • Farmington Hills, MI 48335
Cust.Care: 800/742-5842 • Cust. Fax: 800/564-0119
- **CENTRAL STATES**
5900 Deramus Avenue • Kansas City, MO 64120
Cust.Care: 800/742-5842 • Cust. Fax: 888/448-3540
- **MID-CONTINENT**
7177 Railspur Street • Houston, TX 77078
Cust.Care: 800/742-5842 • Cust. Fax: 888/448-3537
- **PERMIAN BASIN**
2628 Remington Road • Odessa, TX 79763
Local Tel.: 915/332-1489 • Local Fax: 915/332-4924
- **ROCKY MOUNTAIN**
5045 Paris Street • Denver, CO 80239
Cust.Care: 800/742-5842 • Cust. Fax: 888/448-3528
- **PACIFIC - NORTH**
22633 83rd Ave. So. • Kent, WA 98032
Cust.Care: 800/742-5842 • Cust. Fax: 888/448-3530
- **MID-ATLANTIC**
4901 Kesslersville Road • Easton, PA 18040
Cust.Care: 800/742-5842 • Cust. Fax: 800/696-6447
- **PACIFIC - SOUTH**
20934 So. Santa Fe Ave. • Long Beach, CA 90810
Cust.Care: 800/742-5842 • Cust. Fax: 800/448-3542

VICTAULIC COMPANY OF CANADA

65 Worcester Road • Rexdale, Ontario • Canada M9W 5N7
Phone: 416/675-5575 • FAX: 416/675-5565 • e-mail: viccanada@victaulic.com

Canadian Sales Offices and Service Centers

- **EASTERN**
975 rue Selkirk • Pointe Claire, PQ H9R 4S4
Phone: 514/426-3500 • FAX: 514/426-2818
- **ONTARIO - NORTH**
1070 Elisabella Street • Sudbury, ON P3A 5K2
Phone: 705/560-9595 • FAX: 705/560-9490
- **PACIFIC**
Unit 5, 7560 Vantage Way • Delta, BC V4G 1H1
Phone: 604/940-3301 • FAX: 604/940-3360
- **ONTARIO - SOUTH**
65 Worcester Road • Rexdale, ON M9W 5N7
Phone: 416/675-5575 • FAX: 416/675-5729
- **WESTERN**
11659 180th Street NW • Edmonton, AB T5S 2H6
Phone: 780/452-0680 • FAX: 780/452-2430

VICTAULIC INTERNATIONAL

P.O. Box 31 • Easton, PA, USA 18044-0031
4901 Kesslersville Road • Easton, PA, USA 18040
Phone: 610/559-3300 • FAX: 610/559-3608
e-mail: vicintl@victaulic.com

VICTAULIC AMERICA LATINA

P.O. Box 31 • Easton, PA, USA 18044-0031
4901 Kesslersville Road • Easton, PA, USA 18040
Phone: 610/559-3300 • FAX: 610/559-3608
e-mail: vicintl@victaulic.com

VICTAULIC EUROPE

Prijkelstraat 36
9810 Nazareth Belgium
Phone: 011-32-93-811500 • FAX: 011-32-93-804438

VICTAULIC ASIA-PACIFIC

541 Orchard Road, #08-04, Liat Towers
Singapore 238881
Phone: 011-65-235-3035 • FAX: 011-65-235-0535

This product shall be manufactured by Victaulic Company. All products to be installed in accordance with current Victaulic installation/assembly instructions.
Victaulic reserves the right to change product specifications, designs and standard equipment without notice and without incurring obligations.