

FireLock NXT™ AutoConvert Preaction Valve

SERIES 769

Preaction Electric AutoConvert Dry Trim

HANG THESE INSTRUCTIONS ON THE INSTALLED VALVE FOR EASY FUTURE REFERENCE



WARNING

WARNING



- Failure to follow instructions and warnings can cause product failure, resulting in serious personal injury and property damage.
- Read and understand all instructions before attempting to install any Victaulic piping products.
- Wear safety glasses, hardhat, and foot protection.
- Save this installation, maintenance, and testing manual for future reference.

If you need additional copies of any literature, or if you have any questions concerning the safe installation and operation of this product, contact Victaulic, P.O. Box 31, Easton, PA 18044-0031, USA, Telephone: 1-800 PICK VIC, e-mail: pickvic@victaulic.com.

FireLock NXT™ AutoConvert Preaction Valve

SERIES 769

Preaction Electric AutoConvert Dry Trim

TABLE OF CONTENTS

Hazard Identification 1

Installer Safety Instructions 2

 General 2

 Maintenance and Testing 2

Introduction 2

Trim Dimensions 3

Exploded View Drawing – Trim Components 4

Exploded View Drawing – Internal Valve Components 6

Description - AutoConvert Trim Assembly 7

Latching Solenoid Module Cutaway 7

Section View Drawing and Description –
 Series 776 Low-Pressure Actuator 8

Section View Drawing and Description –
 Series 746-LPA Dry Accelerator 9

Air Supply Requirements 10

 Compressor Sizing 10

 Base or Riser-Mounted Air Compressors 10

 Vicaltic Series 757P Air Maintenance Trim Assembly
 (AMTA) with Pressure Switch Option 10

 Shop Air or Tank-Mounted Air Compressors 11

 Vicaltic Series 757 Regulated Air Maintenance
 Trim Assembly (AMTA) Option 11

 Compressor Requirements and Settings for
 Series 769 FireLock NXT Preaction Valves
 Installed with Series 746-LPA Dry Accelerators 11

 Settings for Air Supervisory Pressure Switches
 and Alarm Pressure Switches 11

 Remote System Test Valve Requirements 11

Important Installation Information 11

Valve/Trim Installation 12

 Compression Fitting and Tube Installation 12

Hydrostatic Testing 12

System Sensor PDRP-2001 Field Wiring Diagram (Standard) 14

System Sensor PDRP-2001 Field Wiring Diagram
(Standard, Low-Pressure Switch - Double-Interlocked,
Electric-Pneumatic/Electric) 15

Potter PFC-4410RC Field Wiring Diagram (Standard) 16

Potter PFC-4410RC Field Wiring Diagram
(Standard, Low-Pressure Switch - Double-Interlocked,
Electric-Pneumatic/Electric) 17

Sample Program for System Sensor PDRP-2001 Panel 18

Sample Program for Potter Signal PFC-4410RC Panel 19

Placing the System in Service 20

External Inspection 26

 Weekly Inspection 26

 Monthly Inspection 26

Required Tests 27

 Main Drain Test 27

 Water Flow Alarm Test 28

 AutoConvert System Test 29

 Water Level and Low Air Alarm Tests 32

Required Operational (Trip) Tests 35

 Partial Operational (Trip) Test 35

 Full Operational (Trip) Test 36

Required Internal Inspection 38

Maintenance 41

 Removing and Replacing the Clapper Seal 41

 Removing and Replacing the Clapper Assembly 43

 Installing the Cover Plate Gasket and Cover Plate 45

 Removing and Replacing the Diaphragm Assembly 46

 Replacing the Strainer Screen for Series 776
 Low-Pressure Actuators 47

Troubleshooting – Series 776 Low-Pressure Actuator 48

Troubleshooting – Series 746-LPA Dry Accelerator 48

Troubleshooting – Series 753-E Solenoid Valve 48

Troubleshooting – AutoConvert Trim Assembly 48

Troubleshooting – System 49

HAZARD IDENTIFICATION



Definitions for identifying the various hazard levels are provided below. When you see this symbol, be alert to the possibility of personal injury. Carefully read and fully understand the message that follows.

WARNING

- The use of the word “WARNING” identifies the presence of hazards or unsafe practices that could result in death or serious personal injury if instructions, including recommended precautions, are not followed.

CAUTION

- The use of the word “CAUTION” identifies possible hazards or unsafe practices that could result in personal injury and product or property damage if instructions, including recommended precautions, are not followed.

NOTICE



- The use of the word “NOTICE” identifies special instructions that are important but not related to hazards.

FireLock NXT™ AutoConvert Preaction Valve

SERIES 769

Preaction Electric AutoConvert Dry Trim

INSTALLER SAFETY INSTRUCTIONS

 WARNING	
	<ul style="list-style-type: none"> • An experienced, trained installer must install this product in accordance with all instructions. These instructions contain important information. • Depressurize and drain the piping system before attempting to install, remove, adjust, or maintain any Victaulic piping products.
	<p>Failure to follow these instructions can cause product failure, resulting in serious personal injury and/or property damage.</p>

GENERAL

1. **Read and understand all instructions and refer to the trim diagrams before proceeding with the installation, maintenance, and testing of this Victaulic Series 769 FireLock NXT Preaction Valve with AutoConvert trim.**
2. **Inspect the shipment.** Make sure all components are included in the shipment and that all necessary tools are available for installation.
3. **Use only recommended accessories.** Accessories and equipment that are not approved for use with this valve may cause improper system operation.
4. **Wear safety glasses, hardhat, foot protection, and hearing protection.** Wear hearing protection if you are exposed to long periods of noisy job-site operations.
5. **Prevent back injury.** Larger and pre-trimmed valves are heavy and require more than one person or mechanical lifting equipment to position and install the assembly. Always practice proper lifting techniques.
6. **Avoid using electrically powered tools in dangerous environments.** When using electrically powered tools for installation, make sure the area is moisture-free. Keep the work area well lit, and allow enough space to accommodate proper installation of the valve, trim, and accessories.
7. **Watch for pinch points.** Do not place fingers under the valve body where they could be pinched by the weight of the valve. Use caution around spring-loaded components (i.e. clapper assembly).
8. **Keep work areas clean.** Cluttered areas, benches, and slippery floors can create hazardous working conditions.
9. **PROTECT THE SYSTEM FROM FREEZING CONDITIONS. THE VALVE AND SUPPLY PIPING MUST BE PROTECTED FROM FREEZING TEMPERATURES AND MECHANICAL DAMAGE.**
10. **IF THE INLET WATER SUPPLY IS INTERRUPTED FOR ANY REASON, AND SYSTEM SUPPLY PRESSURE TO THE VALVE DECREASES, MAKE SURE THE DIAPHRAGM CHARGE LINE IS FULLY PRESSURIZED BEFORE PLACING THE SYSTEM BACK IN SERVICE.**

MAINTENANCE AND TESTING

1. **Notify the authority having jurisdiction.** Always notify the authority having jurisdiction before performing any maintenance that eliminates the fire protection provided by the system.
2. **Follow NFPA requirements for system testing and inspection schedules.** The building owner or their representative is responsible for inspecting the system in accordance with current NFPA-25 requirements or in accordance with the requirements of the local authority having jurisdiction (whichever is more stringent).
3. **Depressurize and drain the system completely before performing any maintenance.** Water under pressure can cause the cover plate to blow off during removal if the system is not depressurized and drained completely.
4. **Protect the valve from freezing temperatures, foreign matter, and corrosive atmospheres.** Any condition that might degrade the system or affect system performance must be avoided.

INTRODUCTION

The following instructions are a guide for proper installation of Victaulic Series 769 FireLock NXT Preaction Valves with AutoConvert Trim. These instructions involve pipe that is properly prepared and grooved in accordance with current Victaulic specifications.

NOTICE

- **Drawings and/or pictures in this manual may be exaggerated for clarity.**
- **This product and this installation, maintenance, and testing manual contain trademarks, copyrights, and/or patented features that are the exclusive property of Victaulic.**

FireLock NXT™ AutoConvert Preaction Valve

SERIES 769

Preaction Electric AutoConvert Dry Trim

TRIM DIMENSIONS

THE GRAPHIC SHOWN BELOW IS REPRESENTATIVE OF THE 1 ½ – 2-INCH/48.3 – 60.3-MM TRIM CONFIGURATIONS.

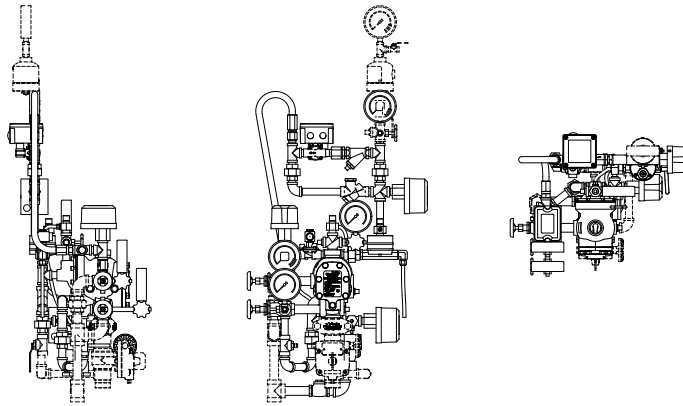

THE GRAPHIC SHOWN BELOW IS REPRESENTATIVE OF THE 2 ½ – 8-INCH/73.0 – 219.1-MM TRIM CONFIGURATIONS.

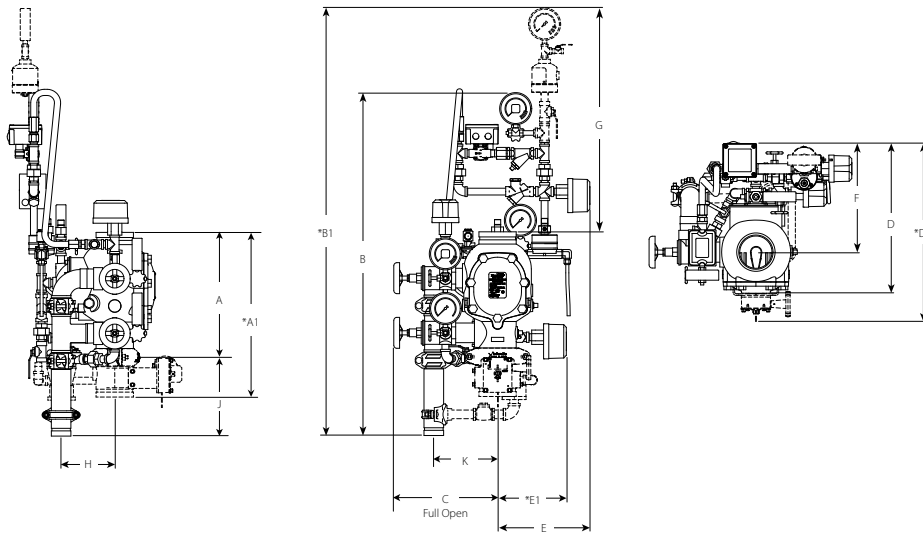

Size		Dimensions – inches/mm														Aprx. Weight Ea. lbs/kg	
Nominal Size inches	Actual Out. Dia. inches	A	A1*	B	B1*	C	D	D1*	E	E1	F	G*	H	J	K	Without Trim	With Trim
1 ½	1.900	9.00	16.43	36.50	46.75	10.75	14.75	16.75	12.00	8.50	11.75	29.75	3.04	9.17	6.98	16.7	43.0
40	48.3	228.60	417.32	927	1187	273	375	425	304.8	216	298	756	77.21	232.91	177.29	7.6	19.5
2	2.375	9.00	16.43	36.50	46.75	10.75	14.75	16.75	12.00	8.50	11.75	29.75	3.04	9.17	6.98	17.0	43.0
50	60.3	228.60	417.32	927	1187	273	375	425	304.8	216	298	756	77.21	232.91	177.29	7.7	19.5
2 ½	2.875	12.61	16.50	41.50	51.50	11.50	16.00	18.50	11.75	9.00	11.50	28.00	3.90	10.50	6.93	41.0	65.0
65	73.0	320.29	419.10	1054	1308	292	406	470	298.5	229	292	711	99.06	266.70	176.02	18.7	29.5
76.1 mm	3.000	12.61	16.50	41.50	51.50	11.50	16.00	18.50	11.75	9.00	11.50	28.00	3.90	10.50	6.93	41.0	65.0
	76.1	320.29	419.10	1054	1308	292	406	470	298.5	229	292	711	99.06	266.70	176.02	18.7	29.5
3	3.500	12.61	16.50	41.50	51.50	11.50	16.00	18.50	11.75	9.00	11.50	28.00	3.90	10.50	6.93	41.0	65.0
80	88.9	320.29	419.10	1054	1308	292	406	470	298.5	229	292	711	99.06	266.70	176.02	18.7	29.5
4	4.500	15.03	19.78	42.25	52.50	13.25	18.25	21.50	12.00	9.00	13.50	27.75	6.25	9.62	8.46	59.0	95.0
100	114.3	381.76	502.41	1073	1334	337	464	546	304.8	229	343	705	158.75	244.34	214.88	26.7	43.0
165.1 mm	6.500	16.00	22.00	42.50	52.75	13.75	19.25	23.75	12.00	8.50	13.75	27.00	6.20	9.62	8.84	80.0	116.0
	165.1	406.40	558.80	1080	1340	349	489	603	304.8	216	349	686	157.48	244.34	224.53	36.2	52.6
6	6.625	16.00	22.00	42.50	52.75	13.75	19.25	23.75	12.00	8.50	13.75	27.00	6.20	9.62	8.84	80.0	116.0
150	168.3	406.40	558.80	1080	1340	349	489	603	304.8	216	349	686	157.48	244.34	224.53	36.2	52.6
8	8.625	17.50	22.94	42.25	52.25	15.25	22.00	27.00	12.75	8.75	14.75	25.50	6.05	9.40	10.21	122.0	158.0
200	219.1	444.50	582.67	1073	1327	387	559	686	323.9	222	375	648	153.67	238.76	259.33	55.3	71.6

NOTES: Components shown as dotted lines denote optional equipment

* Measurements denoted with an asterisk take optional equipment into account

Optional drain connection kit is shown for reference and takeout dimensions.

The 1 ½ – 2-inch/48.3 – 60.3-mm configurations contain ¾-inch/19-mm drain valves. The 2 ½ – 3-inch/73.0 – 88.9-mm configurations contain 1 ¼-inch/31-mm drain valves. The 4 – 8-inch/114.3 – 219.1-mm configurations contain 2-inch/50-mm drain valves.

FireLock NXT™ AutoConvert Preaction Valve

SERIES 769

Preaction Electric AutoConvert Dry Trim

EXPLODED VIEW DRAWING – TRIM COMPONENTS

SERIES 769 FIRELOCK NXT PREACTION VALVE – ELECTRIC AUTOCONVERT DRY TRIM (OPTIONAL ACCESSORIES ALSO SHOWN)



Bill of Materials

- 1 Series 769 FireLock NXT Preaction Valve
- 2 FireLock Rigid Coupling (Optional/Sold Separately – Comes Standard when VQR Assembly is Ordered)
- 3 Water Supply Main Control Valve (Optional/Sold Separately – Comes Standard when VQR Assembly is Ordered)
- 4 Drain Swing Check Valve
- 5 Drip Cup with Cap
- 6 Alarm Pressure Switch (Optional/Sold Separately – Comes Standard when VQR Assembly is Ordered)
- 7 Series 729 Drip Check Valve
- 8 Diaphragm-Charge-Line Ball Valve (Normally Open)
- 9 3-in-1 Strainer/Check/Restrictor Assembly
- 10 Series 760 Water Motor Alarm (Optional/Sold Separately)
- 11 Alarm Test Ball Valve
- 12 Diaphragm-Charge-Line Pressure Gauge (0-300 psi/0-2068 kPa/0-20.7 Bar)
- 13 Series 749 Auto Drain
- 14 Air Supervisory Pressure Switch (Optional/Sold Separately – Comes Standard when VQR Assembly is Ordered)
- 15 System Pressure Gauge (0-80 psi/0-552 kPa/0-5.5 Bar with Retard)
- 16 Water Supply Main Drain Valve - Flow Test
- 17 Water Supply Pressure Gauge (0-300 psi/0-2068 kPa/0-20.7 Bar)
- 18 Drain Connection Kit (Optional/Sold Separately – Comes Standard when VQR Assembly is Ordered)
- 19 Gauge Valve
- 20 System Main Drain Valve
- 21 Series 755 Manual Pull Station
- 22 Series 748 Ball Check Valve
- 23 Series 746-LPA Dry Accelerator (Optional/Sold Separately)
- 24 Series 753-E Solenoid Valve
- 25 Latching Solenoid Assembly
- 26 Braided Stainless Steel Flex Hose
- 27 Series 776 Low-Pressure Actuator
- 28 AutoConvert Assembly Air Pressure Gauge (0-80 psi/0-5.5 Bar with Retard)
- 29 Strainer
- 30 AutoConvert Assembly Pre-Set Air Pressure Switch

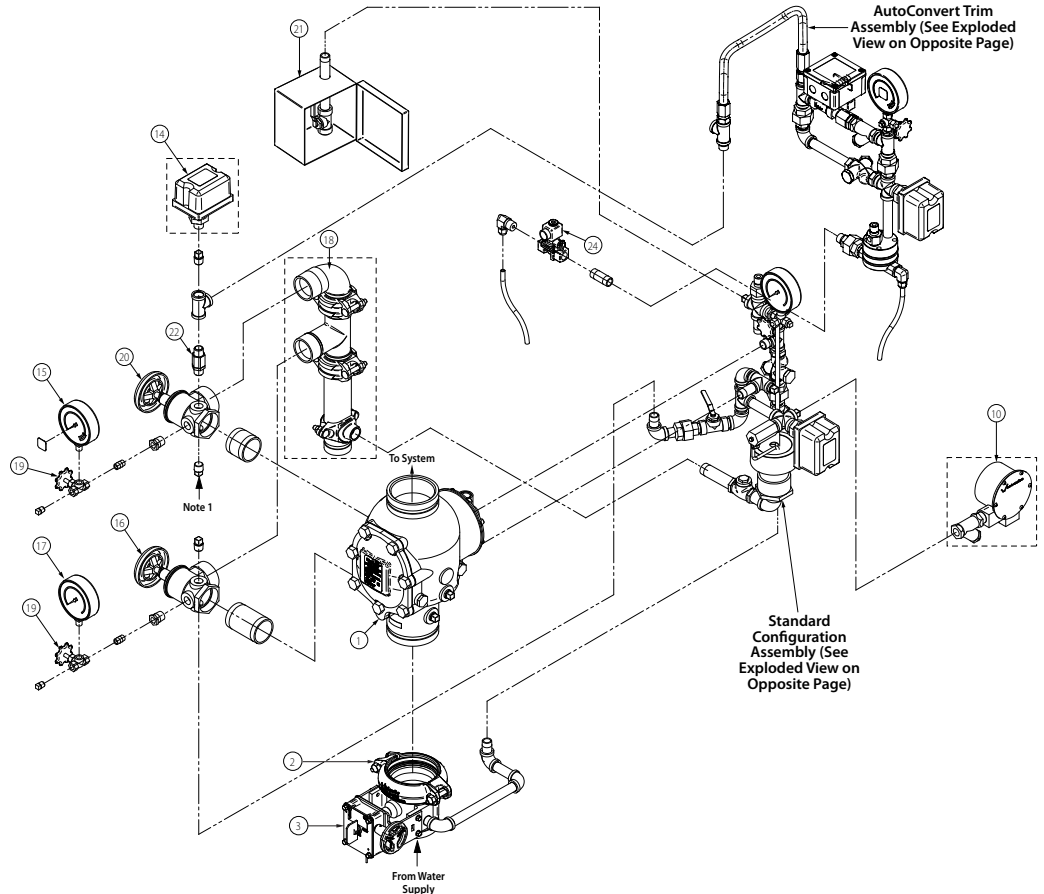

NOTE 1: Connection point for the Series 75D Water Column Device Kit

For information regarding installation of the Series 75B Supplemental Alarm Device or the Series 7C7 Air Maintenance/Compressor Assembly (not shown), refer to the instructions supplied with the product.

FireLock NXT™ AutoConvert Preaction Valve

SERIES 769

Preaction Electric AutoConvert Dry Trim

Exploded View of AutoConvert Trim Assembly

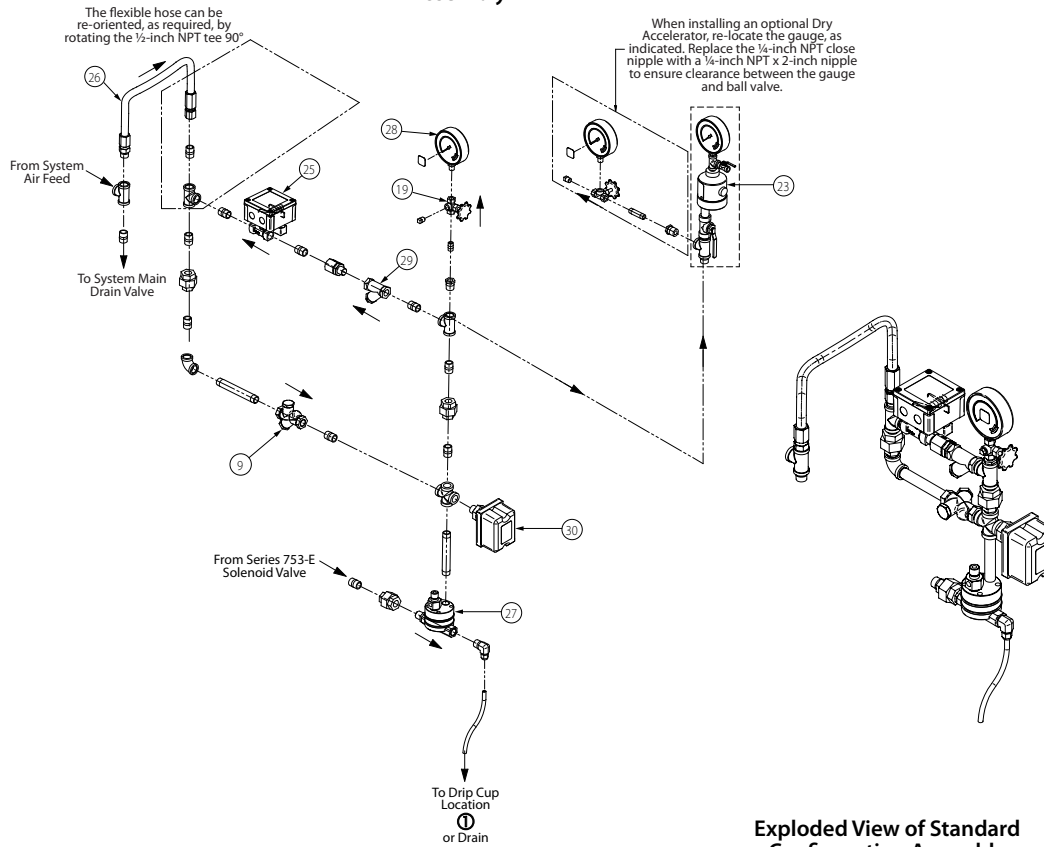

Exploded View of Standard Configuration Assembly

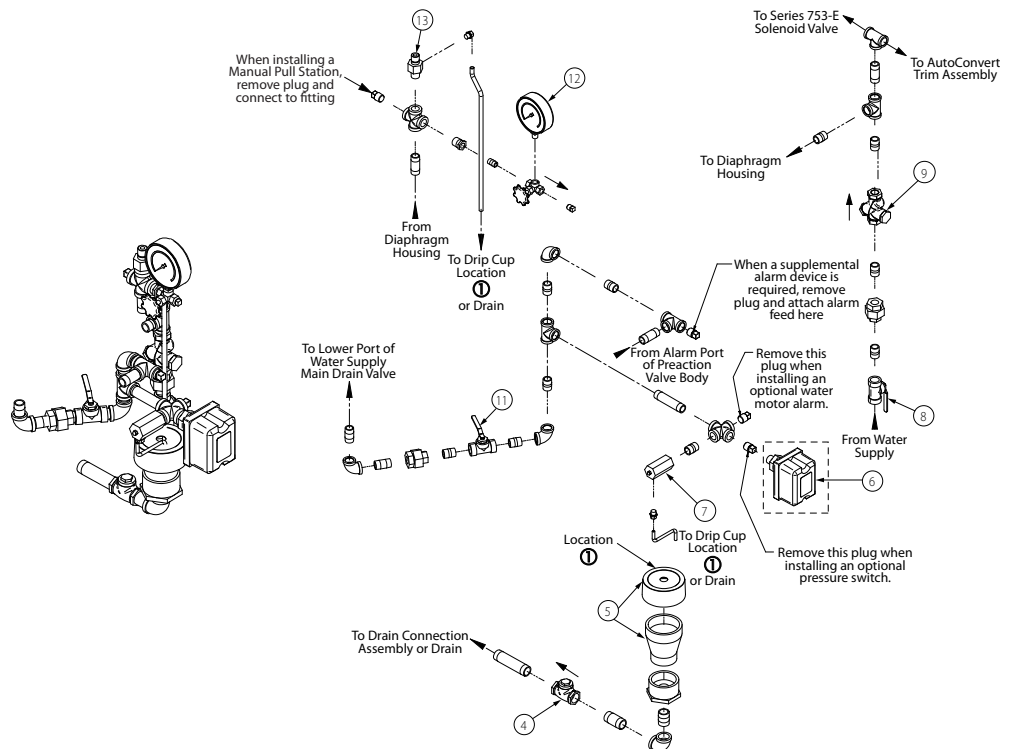

FireLock NXT™ AutoConvert Preaction Valve

SERIES 769

Preaction Electric AutoConvert Dry Trim

EXPLODED VIEW DRAWING – INTERNAL VALVE COMPONENTS

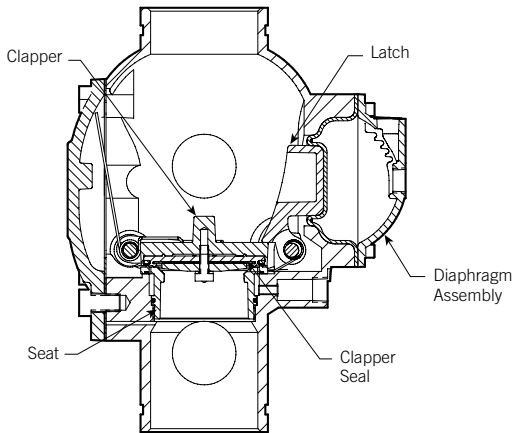

NOTE: VALVE IS SHOWN ABOVE IN THE "SET" POSITION

Exaggerated for Clarity

Bill of Materials

- | | |
|--|--|
| 1 Valve Body | 12 Cover Plate |
| 2 Clapper | 13 Cover Plate Gasket |
| 3 Clapper Seal | 14 Cover Plate Bolts* |
| 4 Seal Ring | 15 Latch |
| 5 Seal Washer | 16 Latch Spring |
| 6 Seal Retaining Ring | 17 Latch Shaft Bushing and O-Ring (Qty. 2) |
| 7 Seal Assembly Bolt | 18 Diaphragm |
| 8 Bolt Seal | 19 Diaphragm Cover |
| 9 Clapper Spring | 20 Diaphragm Cover Cap Screws (Qty. 8) |
| 10 Clapper Shaft | 21 Latch Shaft |
| 11 Clapper Shaft Bushing and O-Ring (Qty. 2) | |

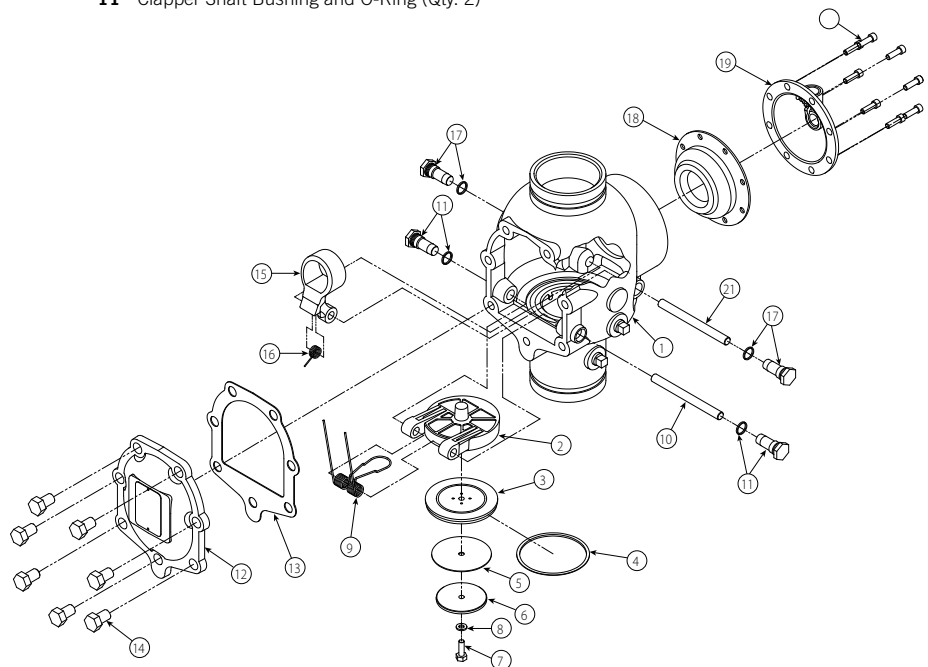

* **NOTE:** The 1½-inch/48.3-mm and 2-inch/60.3-mm valve sizes contain washers under the heads of the cover plate bolts.

FireLock NXT™ AutoConvert Preaction Valve

SERIES 769

Preaction Electric AutoConvert Dry Trim

DESCRIPTION – AUTOCONVERT TRIM ASSEMBLY

The AutoConvert Trim Assembly consists of a latching solenoid module and a Series 776 Low-Pressure Actuator. The AutoConvert Trim Assembly monitors incoming power to the Fire Alarm Control Panel (FACP) and allows for continuous fire protection in the event of an AC power loss, without draining battery backup.

In the event of an AC power loss, the latching solenoid module receives a quick electrical pulse from the FACP to latch open. The latching solenoid module stays in the open position without requiring additional current draw. This allows the FACP to continuously monitor the system and provide alarms in the event of a fire condition for the normal life of the battery backup or until power is restored.

In the open condition, air is allowed to flow through the latching solenoid module to the Series 776 Low-Pressure Actuator and converts the system to a non-interlocked condition. An air loss in the system piping or an electrical release from the FACP would allow the preaction valve to actuate and fill the sprinkler system piping with water.

The system continues to act as a dry valve until AC power is restored. When AC power is restored, the latching solenoid module receives another quick electrical pulse from the FACP to latch closed. The preaction system then returns to its standard release method. Manual resetting of the system is not required.

Bill of Materials

- 1 Braided Stainless Steel Flex Hose
- 2 Latching Solenoid Module
- 3 AutoConvert Assembly Air Pressure Gauge (0-80 psi/0-5.5 Bar with Retard)
- 4 Gauge Valve
- 5 Series 776 Low-Pressure Actuator
- 6 3-in-1 Strainer/Check/Restrictor Assembly
- 7 Strainer
- 8 Restrictor
- 9 AutoConvert Assembly Pre-Set Air Pressure Switch

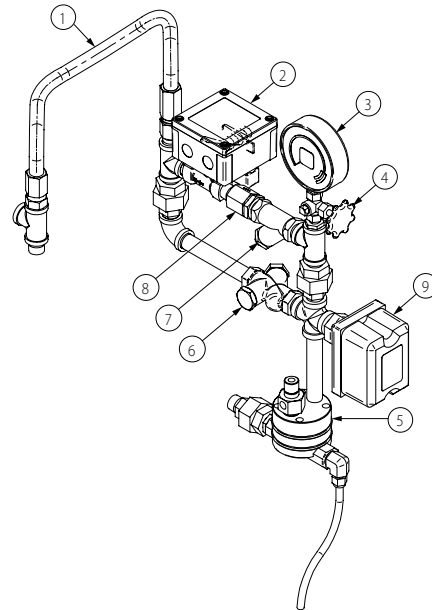

LATCHING SOLENOID MODULE CUTAWAY

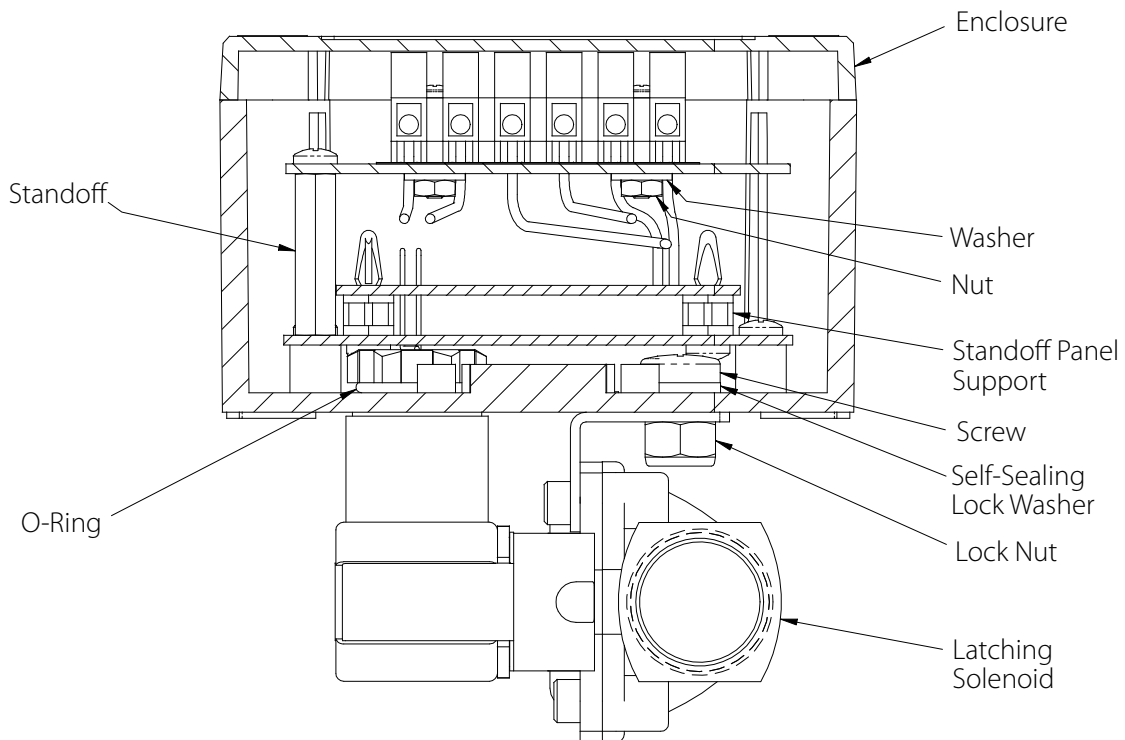

FireLock NXT™ AutoConvert Preaction Valve

SERIES 769

Preaction Electric AutoConvert Dry Trim

SECTION VIEW DRAWING AND DESCRIPTION – SERIES 776 LOW-PRESSURE ACTUATOR

The Series 776 Low-Pressure Actuator is located in the trim of Series 769 FireLock NXT Preaction Valves and acts as the trigger for these systems.

Diaphragms separate the low-pressure actuator into three chambers. The upper air chamber controls activation, while the middle and lower chambers act as the water valve.

During setup, system air is applied to the upper chamber of the low-pressure actuator. When the Auto Vent Sleeve of the low-pressure actuator is pulled up, the upper chamber manually sets. Air pressure in the upper chamber holds the Auto Vent closed, while it exerts force on the water seal of the middle chamber.

When the diaphragm charge line is opened, water enters the lower chamber of the low-pressure actuator. Water that enters the low-pressure actuator flows to the middle chamber through the inlet eyelet, which is pressurized by system air pressure in the upper chamber.

Since the area of the lower diaphragm (exposed to water pressure in the middle chamber) is greater than the area of the lower chamber, the lower chamber seals off. Water does not flow to the outlet of the low-pressure actuator, and the supply water pressure creates the water seal.

When system air pressure decays to 7 psi/0.5 Bar, the force exerted by the compression spring in the Auto Vent is greater than the force exerted by air in the upper chamber. The Auto Vent opens, and all air pressure in the upper chamber evacuates.

The upper diaphragm releases water pressure in the middle chamber of the low-pressure actuator, which allows the lower diaphragm to lift and water to flow from the inlet to the outlet. This flow of water releases pressure from the diaphragm charge line of the Series 769 FireLock NXT Preaction Valve, thus allowing the diaphragm to retract. The clapper opens, and water flows into the sprinkler system.

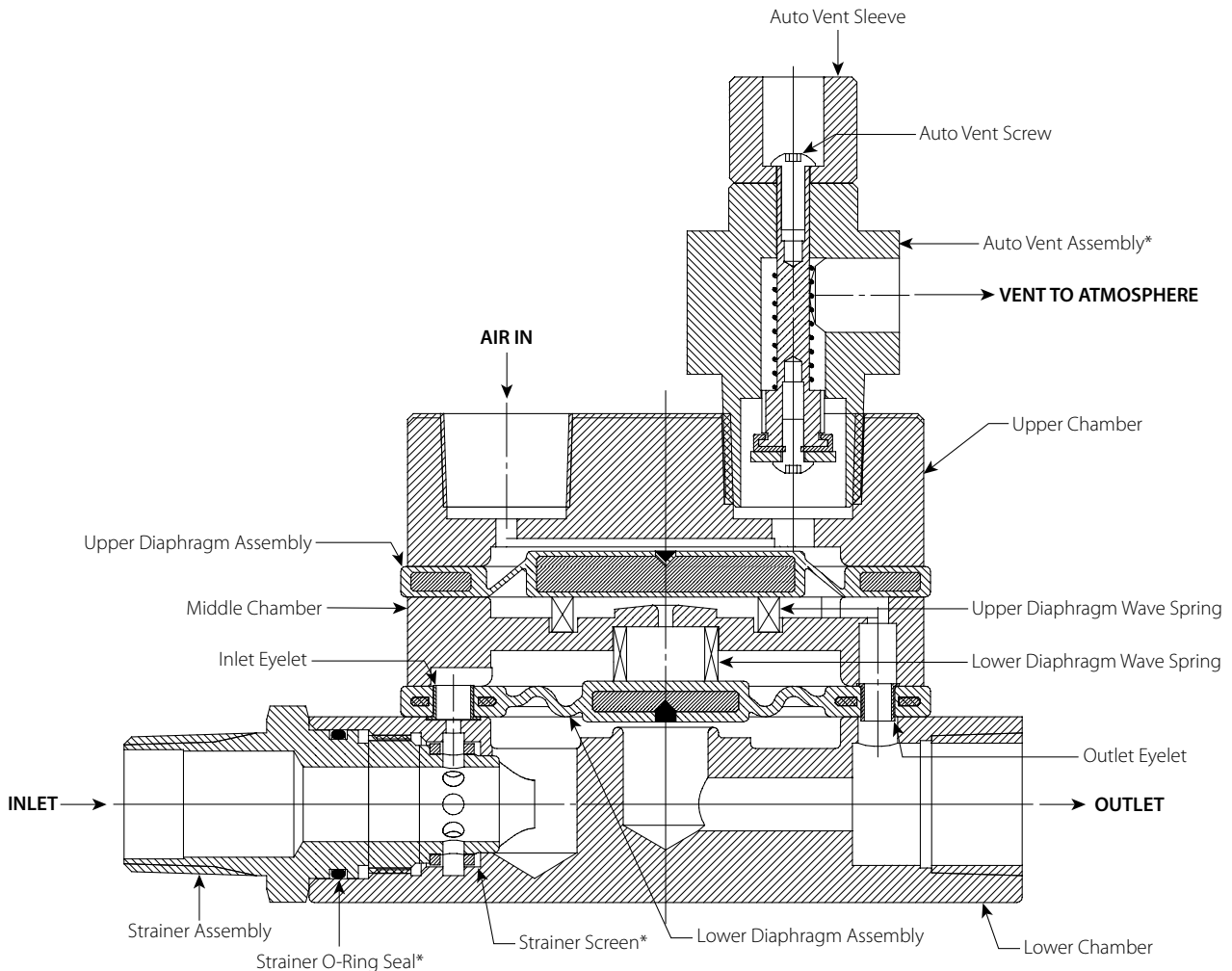

Illustration is exaggerated for clarity

* Denotes components that can be replaced in the field

FireLock NXT™ AutoConvert Preaction Valve

SERIES 769

Preaction Electric AutoConvert Dry Trim

**SECTION VIEW DRAWING AND DESCRIPTION –
SERIES 746-LPA DRY ACCELERATOR
(OPTIONAL)**

The Series 746-LPA Dry Accelerator is a quick-opening device, which exhausts air from the Series 776 Low-Pressure Actuator to speed valve operation.

A diaphragm separates the Series 746-LPA Dry Accelerator into two chambers. The closing chamber contains a compression spring, which maintains the chamber in the closed position. The closed position is maintained as long as the pressure differential between the opening and closing chambers is less than 3psi/0.2Bar.

When the system introduces air pressure into the dry accelerator, air enters the closing chamber and passes through a check valve to the opening chamber. The check valve, which allows flow into the opening chamber, prevents pressure from escaping the opening chamber. Therefore, air can escape only through the restrictor.

When a rapid loss of system air pressure occurs, such as an open sprinkler, air escapes from the closing chamber faster than it escapes from the opening chamber. As the sprinkler system's pressure continues to decay, a differential pressure develops across the diaphragm. When this differential pressure reaches 3 – 5psi/0.2 – 0.3Bar, the opening chamber's pressure overcomes the compression spring's closing force, causing the closing chamber to open to the atmosphere. The closing chamber opens immediately and releases pressure from the actuator, resulting in valve operation.

NOTE: The Series 746-LPA Dry Accelerator must be used only on systems operating below 25psi/1.7 Bar of air. If air pressure higher than 25psi/1.7 Bar is required, the Series 746 Dry Accelerator should be used.

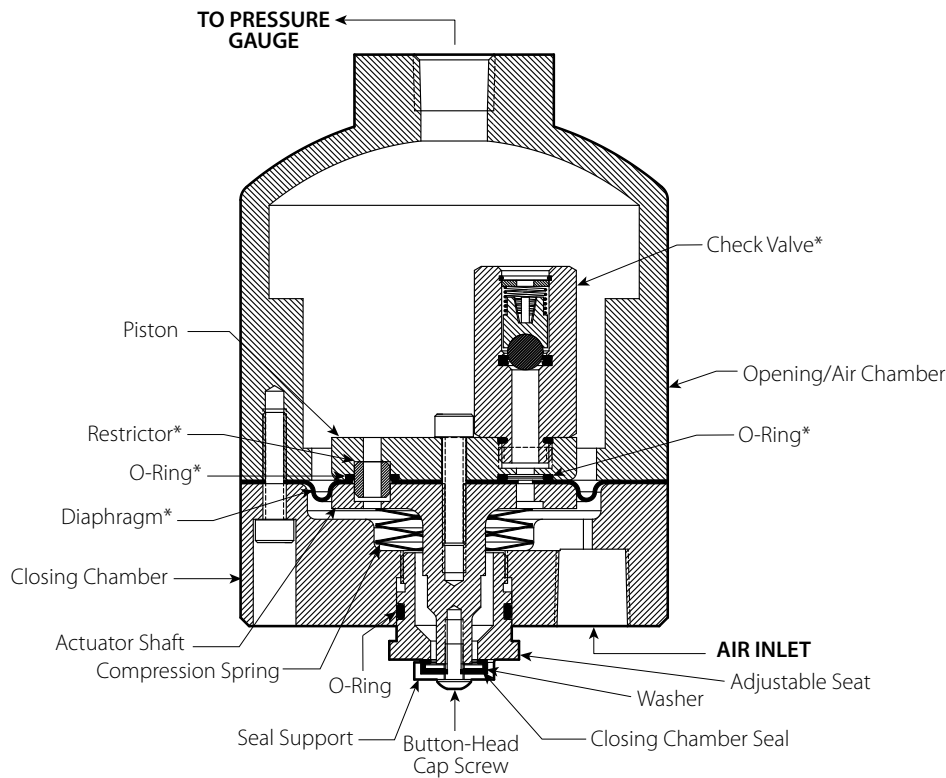

**CROSS-SECTION WITH UPPER CHAMBER ROTATED
45° AND BOLT REMOVED FOR CLARITY**

Illustration is exaggerated for clarity

** Denotes components that can be replaced in the field*

FireLock NXT™ AutoConvert Preaction Valve

SERIES 769

Preaction Electric AutoConvert Dry Trim

AIR SUPPLY REQUIREMENTS

The required air pressure for Series 769 FireLock NXT Preaction Valves is 13 psi/0.9 Bar minimum, regardless of the system supply water pressure. Normal air pressure should not exceed 18 psi/1.2 Bar. Failure to maintain air pressure within the 13 psi/0.9 Bar to 18 psi/1.2 Bar range may reduce system operation response time.

Systems with air pressure higher than 18 psi/1.2 Bar may require the addition of a Series 746-LPA Dry Accelerator. **NOTE:** The Series 746-LPA Dry Accelerator must be used only on systems operating below 25 psi/1.7 Bar of air. If air pressure higher than 25 psi/1.7 Bar is required, the Series 746 Dry Accelerator should be used.

If multiple Series 769 FireLock NXT Preaction Valves are installed with a common air supply, isolate the systems with a spring-loaded, soft-seated ball check valve to ensure air integrity for each system. Good practice is to include a ball valve for isolation and service of each individual system. Multiple valves require shop air or a tank-mounted air compressor.

Set the air pressure to the required system air pressure. Air pressure differing from the required system air pressure could delay system operation response time.

The engineer/system designer is responsible for sizing the compressor so that the entire system is charged to the required air pressure within 30 minutes. **DO NOT** oversize the compressor to provide more airflow. An oversized compressor will slow down or possibly prevent valve operation.

If the compressor fills the system too fast, it may be necessary to restrict the air supply. Restricting the air supply will ensure that air being exhausted from an open sprinkler or manual release valve is not replaced by the air supply system as fast as it is being exhausted.

COMPRESSOR SIZING

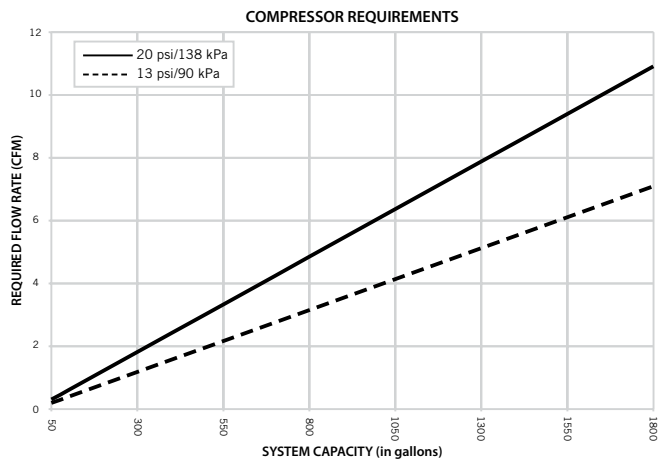

BASE OR RISER-MOUNTED AIR COMPRESSORS

For base or riser-mounted air compressors, the recommended air pressure of 13 psi/0.9 Bar is the “on” or “low” pressure setting for the compressor. The “off” or “high” pressure setting should be 18 psi/1.2 Bar.

When a base or riser-mounted air compressor supplies air to a Series 769 FireLock NXT Preaction Valve, do not install the Victaulic Series 757 Regulated Air Maintenance Trim Assembly (AMTA). In this case, the air line of the compressor connects to the valve trim at the air manifold (refer to the applicable trim drawing). If the compressor is not equipped with a pressure switch, the Series 757P Air Maintenance Trim Assembly with Pressure Switch should be installed.

NOTICE

- The Series 757P AMTA must not be used in any system installed with a Series 746-LPA Dry Accelerator, unless a tank and an air regulator are added.

VICTAULIC SERIES 757P AIR MAINTENANCE TRIM ASSEMBLY (AMTA) WITH PRESSURE SWITCH OPTION

NOTICE

- Refer to the I-757P Air Maintenance Trim Assembly with Pressure Switch Installation Instructions, supplied with the product, for complete installation, electrical, and pressure switch adjustment information.

Bill of Materials

Item	Qty.	Description
1	1	Restrictor (1/2-inch NPT)
2	1	Strainer (1/2-inch NPT)
3	1	Swing Check (1/2-inch NPT)
4	1	Slow-Fill Ball Valve (Normally Open)
5	1	Spring-Loaded, Soft-Seated Check Valve
6	1	Pressure Switch
7	2	Compression Fitting, Straight (1/4-inch NPT x 1/4-inch Tube)
8	1	Copper Tubing (1/4-inch OD)
9	11	Close Nipple (1/2-inch NPT x 1.13)
10	1	Nipple (1/2-inch NPT x 4.00)
11	1	90° Female Elbow (1/2-inch NPT)
12	4	Female Tee (1/2-inch NPT)
13	3	Union (1/2-inch NPT)
14	2	Reducing Bushing (1/2-inch NPT x 1/4-inch NPT)
15	1	Fast-Fill Ball Valve (Normally Closed)
16	1	Pressure Switch Isolation Ball Valve (Normally Open - Lockable)

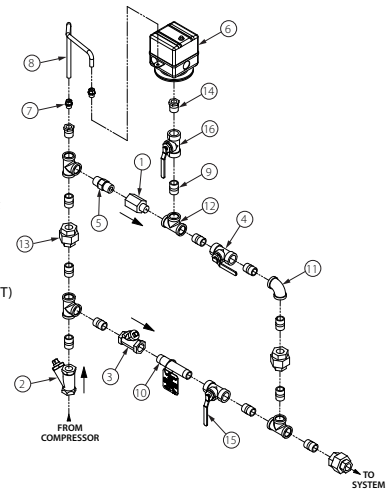

FireLock NXT™ AutoConvert Preaction Valve

SERIES 769

Preaction Electric AutoConvert Dry Trim

SHOP AIR OR TANK-MOUNTED AIR COMPRESSORS

In the event a compressor becomes inoperative, a properly sized tank-mounted air compressor provides the greatest protection for systems.

When shop air or a tank-mounted air compressor is used, the Series 757 Regulated AMTA must be installed. The Series 757 Regulated AMTA provides proper air regulation from the air reservoir to the sprinkler system. Use of an air regulator with a base or riser-mounted air compressor will cause short cycling, resulting in premature wear of the compressor.

For tank-mounted air compressors, the recommended air pressure of 13 psi/0.9 Bar should be used as the set point for the air regulator. The "on" pressure of the compressor should be at least 5 psi/0.3 Bar above the set point of the air regulator.

VICTAULIC SERIES 757 REGULATED AIR MAINTENANCE TRIM ASSEMBLY (AMTA) OPTION

NOTICE

- Victaulic recommends a maximum of two Series 769 FireLock NXT Preaction Valves per Series 757 Regulated AMTA.
- Systems must be isolated with a spring-loaded, soft-seated check valve.

Bill of Materials

- 1 1/8" / 3.2 mm Restrictor
- 2 Slow Fill Ball Valve (Normally Open)
- 3 Air Regulator
- 4 Strainer (100 Mesh)
- 5 Spring-Loaded, Soft-Seated Ball Check Valve
- 6 Fast Fill Ball Valve (Normally Closed)

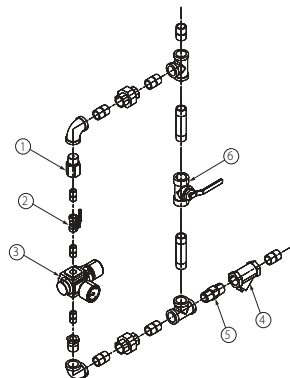

COMPRESSOR REQUIREMENTS AND SETTINGS FOR SERIES 769 FIRELOCK NXT PREACTION VALVES INSTALLED WITH SERIES 746-LPA DRY ACCELERATORS

A tank-mounted air compressor with a Series 757 Regulated AMTA must be used to supply air to a Series 769 FireLock NXT Preaction Valve installed with a Series 746-LPA Dry Accelerator. In the event a compressor becomes inoperative, a properly sized tank-mounted air compressor provides the greatest protection, since air can be supplied continuously to the sprinkler system for an extended time period. In addition, a properly-sized tank-mounted air compressor prevents clogging of the dry accelerator's orifice.

Set the air regulator of the Series 757 Regulated AMTA to a minimum of 13 psi/0.9 Bar. The air regulator of the Series 757 Regulated AMTA is a relief-type design. Any pressure in the system that is above the set point of the air regulator will be released. Therefore, charging the air regulator above the set point could cause premature operation of a valve installed with a Series 746-LPA Dry Accelerator.

SETTINGS FOR AIR SUPERVISORY PRESSURE SWITCHES AND ALARM PRESSURE SWITCHES

1. Air supervisory pressure switches are required for preaction systems and must be set according to the following notes. **NOTE:** Switches for Vic-Quick Risers are pre-set at the factory.
 - 1a. Wire the air supervisory pressure switches to activate a low-pressure alarm signal. **NOTE:** In addition, the local authority having jurisdiction may require a high-pressure alarm. Contact the local authority having jurisdiction for this requirement.
 - 1b. Set the air supervisory pressure switches to activate at 2 – 4 psi/0.1 – 0.3 Bar below the minimum air pressure required (but not lower than 10 psi/0.7 Bar).
 - 1c. Wire the alarm pressure switch to activate a water flow alarm.
 - 1d. Set the alarm pressure switch to activate on a pressure rise of 4 – 8 psi/0.3 – 0.6 Bar above the pressure required.

REMOTE SYSTEM TEST VALVE REQUIREMENTS

The remote system test valve (inspector's test connection) should contain a UL Listed and/or FM Approved valve (normally closed), which can be opened to simulate the operation of a sprinkler.

The remote system test valve (inspector's test connection) should be located at the most hydraulically demanding location in the release system. **NOTE:** Multiple restrictions on the remote system test valve (inspector's test connection) may slow the air decay rate and cause the system to respond slower than required.

The remote system test valve (inspector's test connection) should terminate with an orifice equal to the smallest orifice in the releasing system.

The remote system test valve (inspector's test connection) is used to ensure that water reaches the most remote part of the system within 60 seconds.

IMPORTANT INSTALLATION INFORMATION

1. For proper operation and approval, the Series 769 FireLock NXT Preaction Valve must be installed in accordance with the specific trim diagrams included with the shipment. **NOTE:** Victaulic provides specific trim diagrams for installations involving a Series 746-LPA Dry Accelerator.
2. Before installing the Series 769 FireLock NXT Preaction Valve, flush the water supply piping thoroughly to remove all foreign material.
3. Series 769 FireLock NXT Preaction Valves **MUST NOT** be located in an area where the valve can be exposed to freezing temperatures. In addition, the Series 769 FireLock NXT Preaction Valve **MUST NOT** be located in an area where physical damage may occur.
4. It is the system designer's responsibility to confirm material compatibility of the Series 769 FireLock NXT Preaction Valve, trim, and associated accessories when a corrosive environment or contaminated water is present.
5. **SERIES 769 FIRELOCK NXT PREACTION VALVES MUST BE INSTALLED ONLY IN THE VERTICAL POSITION WITH THE ARROW ON THE BODY POINTING UPWARD.**
6. Air or nitrogen supply to the dry piping system must be clean, dry, and oil-free.
7. Air supplies must be regulated, restricted, and continuous.

FireLock NXT™ AutoConvert Preaction Valve

SERIES 769

Preaction Electric AutoConvert Dry Trim

- When an uninterruptible water flow alarm is required, Victaulic recommends the use of a low-pressure alarm installed on the diaphragm charge line downstream of the strainer/check restrictor. Another option is to install a Series 75B Supplemental Alarm Device.
- Per NFPA 13 requirements, piping must be pitched so that systems can drain properly. For areas that are subject to high levels of condensation, or where piping is not properly pitched, an optional Series 75D Water Column Device kit is available to assist in automatically draining water out of the riser.

VALVE/TRIM INSTALLATION

- Make sure the trim drawing matches the system's requirements.

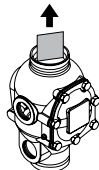
⚠ CAUTION	
	<ul style="list-style-type: none"> Make sure the foam spacer is removed from inside the valve body before attempting to install the valve. <p>Failure to follow this instruction could cause improper valve operation, resulting in personal injury and/or property damage.</p>

- Remove all plastic caps and foam spacers from the valve.
- Apply a small amount of pipe joint compound or Teflon* tape to the external threads of all threaded pipe connections. DO NOT get any tape, compound, or other foreign material into the valve body, pipe nipples, or valve openings.

⚠ CAUTION	
<ul style="list-style-type: none"> Make sure no foreign material gets into the valve body, pipe nipples, or valve openings. If using any material other than Teflon tape, use extra caution so that no material gets into the trim. <p>Failure to follow these instructions could cause improper valve operation, resulting in personal injury and/or property damage.</p>	

- Install the valve, trim, and accessories per the trim drawing.

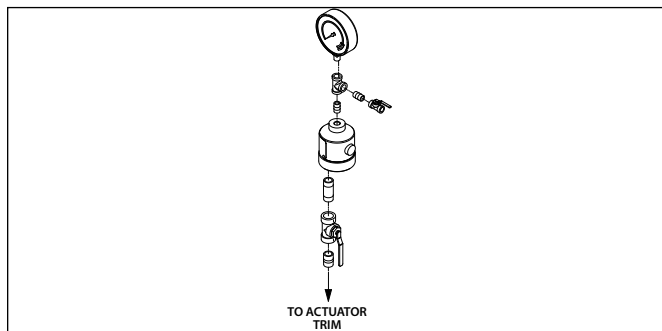

- FOR VALVES INSTALLED WITH A SERIES 746-LPA DRY ACCELERATOR:** Make sure the Series 746-LPA Dry Accelerator is installed in accordance with the trim drawing provided. The end with the vent seal "button" must be installed facing down (toward the trim).
- Supply pressure to the diaphragm charge line by providing an uninterrupted source of water from upstream of the main control valve.

* Teflon is a registered trademark of the DuPont Company

COMPRESSION FITTING AND TUBE INSTALLATION

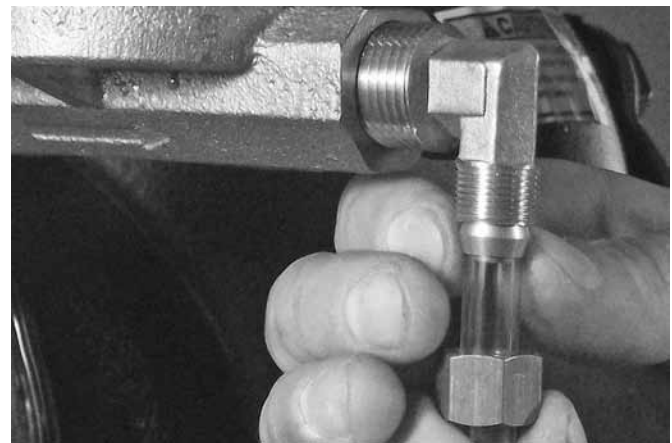
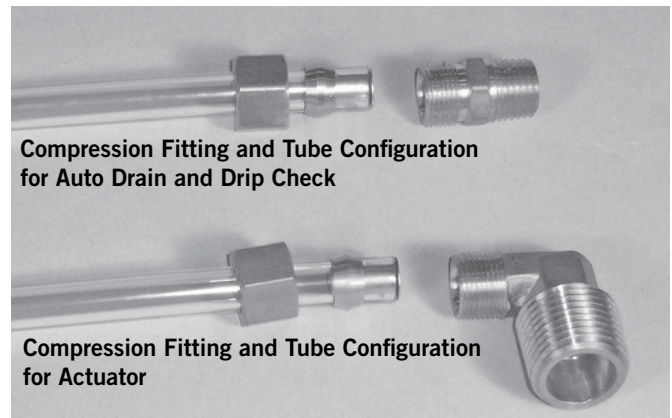

Compression fittings and tubes are provided for connection from the outlet of the auto drain, drip check, and actuator to the drip cup or drain. These compression fittings and tubes must be installed, in accordance with the trim drawing provided. **NEVER** insert a plug into the outlet of the auto drain, drip check, or actuator in place of the compression fitting/tube.

HYDROSTATIC TESTING

⚠ WARNING	
	<ul style="list-style-type: none"> If air testing is required, DO NOT exceed 50 psi/3.4 Bar air pressure. <p>Failure to follow this instruction could result in serious personal injury and/or property damage.</p>

The Victaulic Series 769 FireLock NXT Preaction Valve is UL Listed and FM Approved for a maximum working pressure of 300psi/20.7 Bar and is factory tested to 600psi/41.4 Bar for all sizes. The valve can be hydrostatically tested against the clapper at 200psi/13.8 Bar or 50psi/3.4 Bar above the normal water supply pressure (2-hour limited time period) for acceptance by the authority having jurisdiction.

FireLock NXT™ AutoConvert Preaction Valve

SERIES 769

Preaction Electric AutoConvert Dry Trim

THIS PAGE INTENTIONALLY LEFT BLANK

FireLock NXT™ AutoConvert Preaction Valve

SERIES 769

Preaction Electric AutoConvert Dry Trim

System Sensor* PDRP-2001 Field Wiring Diagram (Standard)

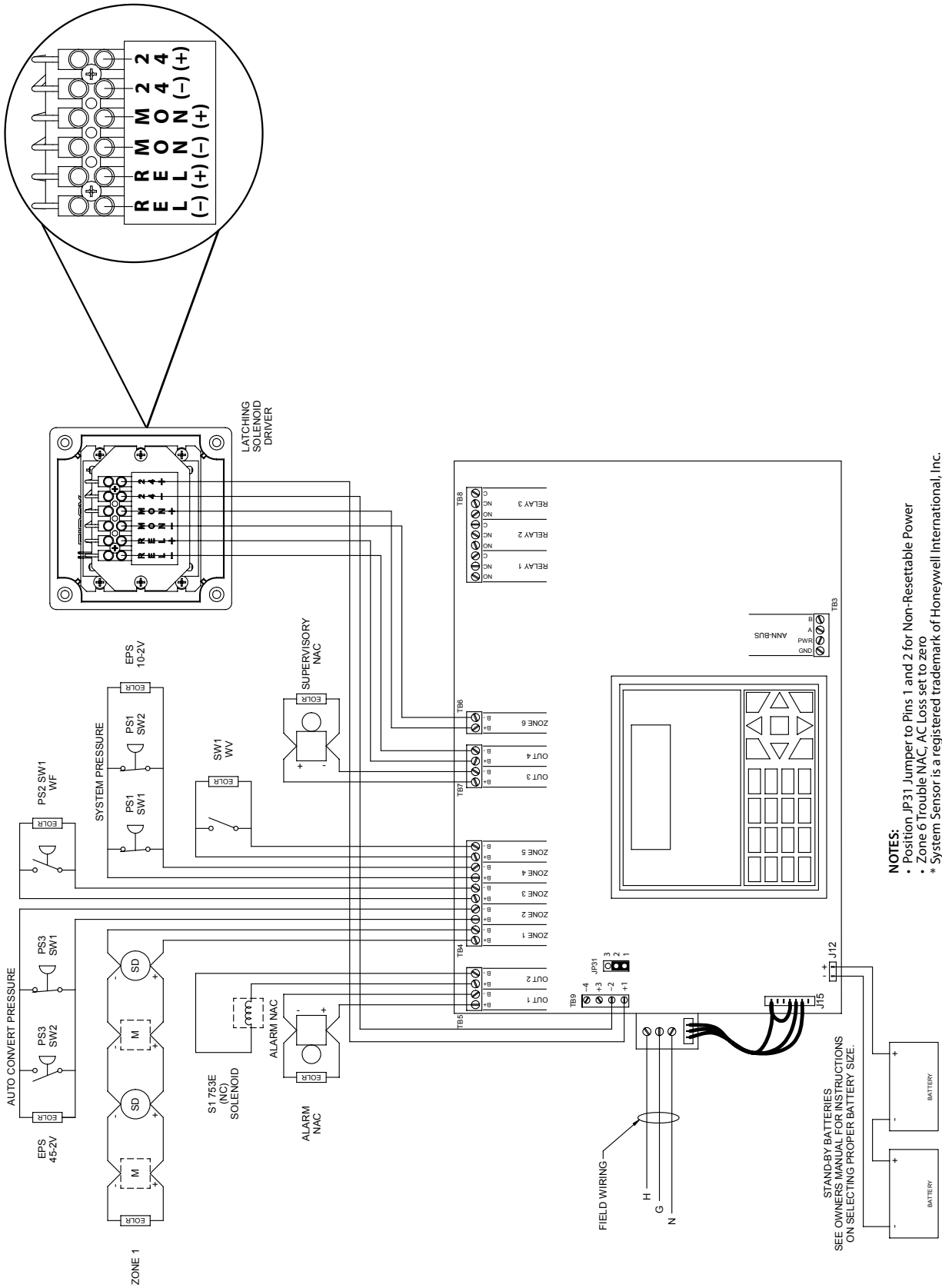

- NOTES:**
- Position JP31 Jumper to Pins 1 and 2 for Non-Resettable Power
 - Zone 6 Trouble NAC, AC Loss set to zero
 - * System Sensor is a registered trademark of Honeywell International, Inc.

FireLock NXT™ AutoConvert Preaction Valve

SERIES 769

Preaction Electric AutoConvert Dry Trim

System Sensor* PDRP-2001 Field Wiring Diagram (Standard, Low-Pressure Switch - Double-Interlocked, Electric-Pneumatic/Electric)

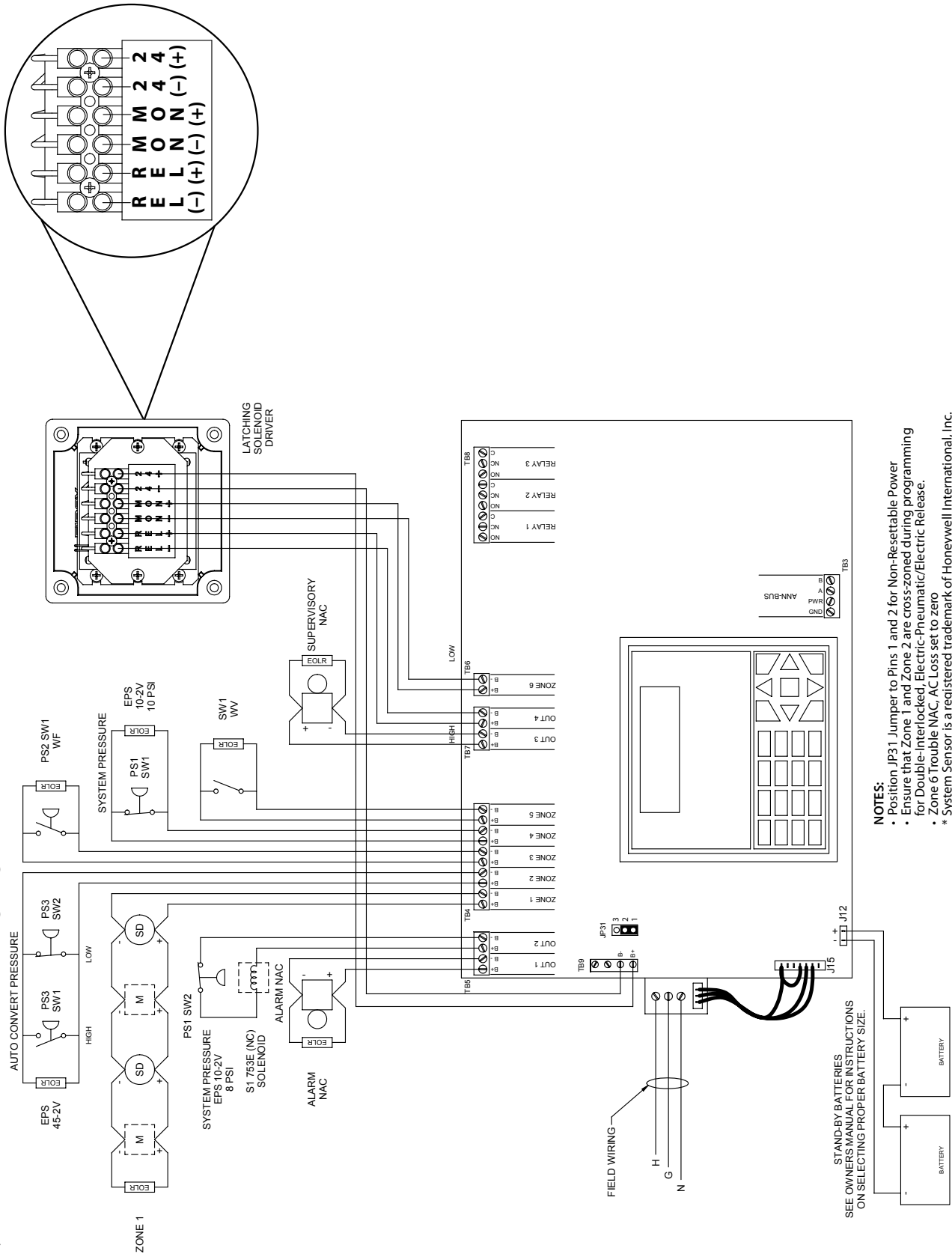

- NOTES:**
- Position JP31 Jumper to Pins 1 and 2 for Non-Resettable Power
 - Ensure that Zone 1 and Zone 2 are cross-zoned during programming for Double-Interlocked, Electric-Pneumatic/Electric Release.
 - Zone 6 Trouble NAC, AC Loss set to zero
 - * System Sensor is a registered trademark of Honeywell International, Inc.

FireLock NXT™ AutoConvert Preaction Valve

SERIES 769

Preaction Electric AutoConvert Dry Trim

Potter* PFC-4410RC Field Wiring Diagram (Standard)

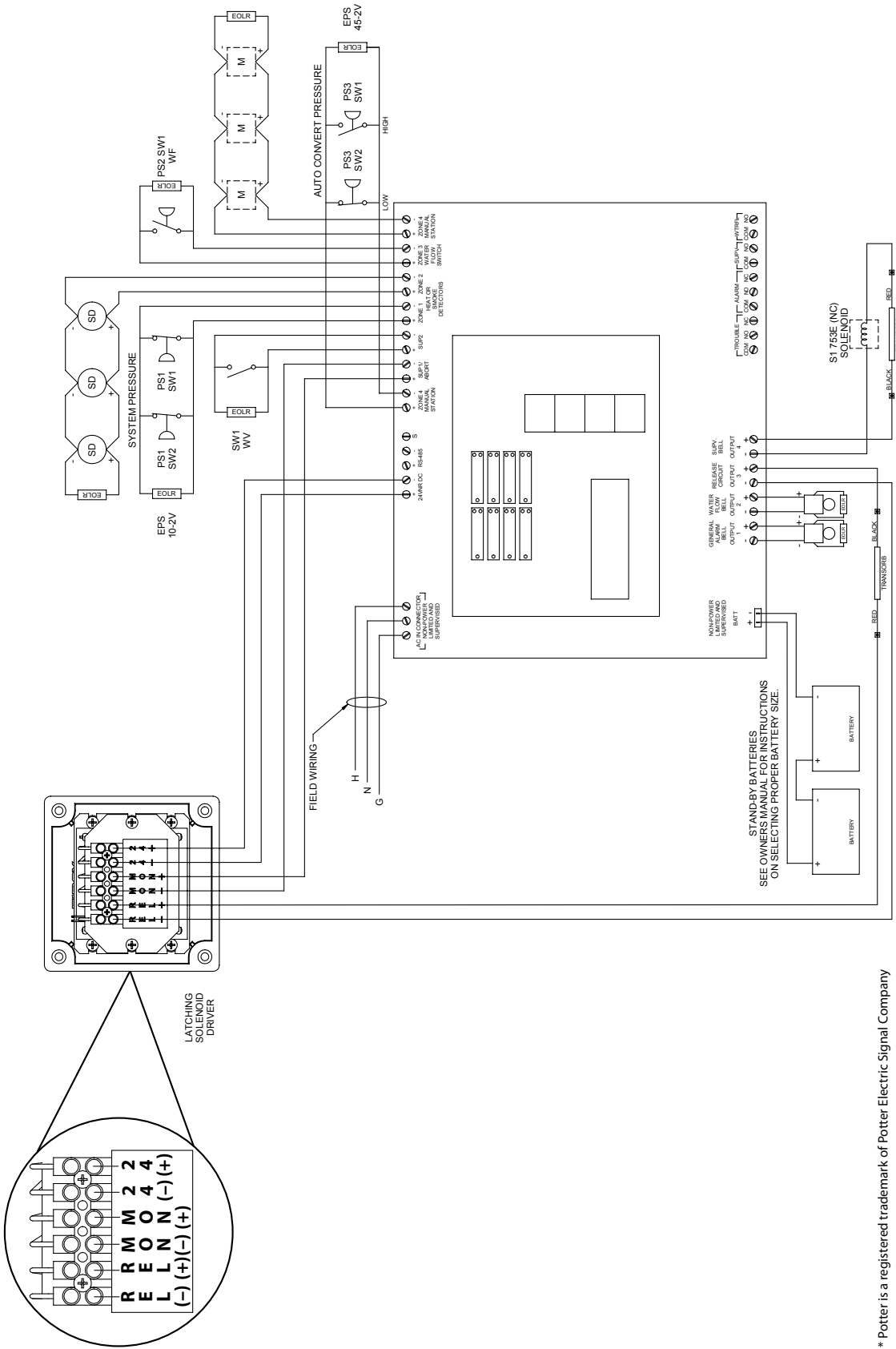

* Potter is a registered trademark of Potter Electric Signal Company

FireLock NXT™ AutoConvert Preaction Valve

SERIES 769

Preaction Electric AutoConvert Dry Trim

Potter* PFC-4410RC Field Wiring Diagram (Standard, Low-Pressure Switch - Double-Interlocked, Electric-Pneumatic/Electric)

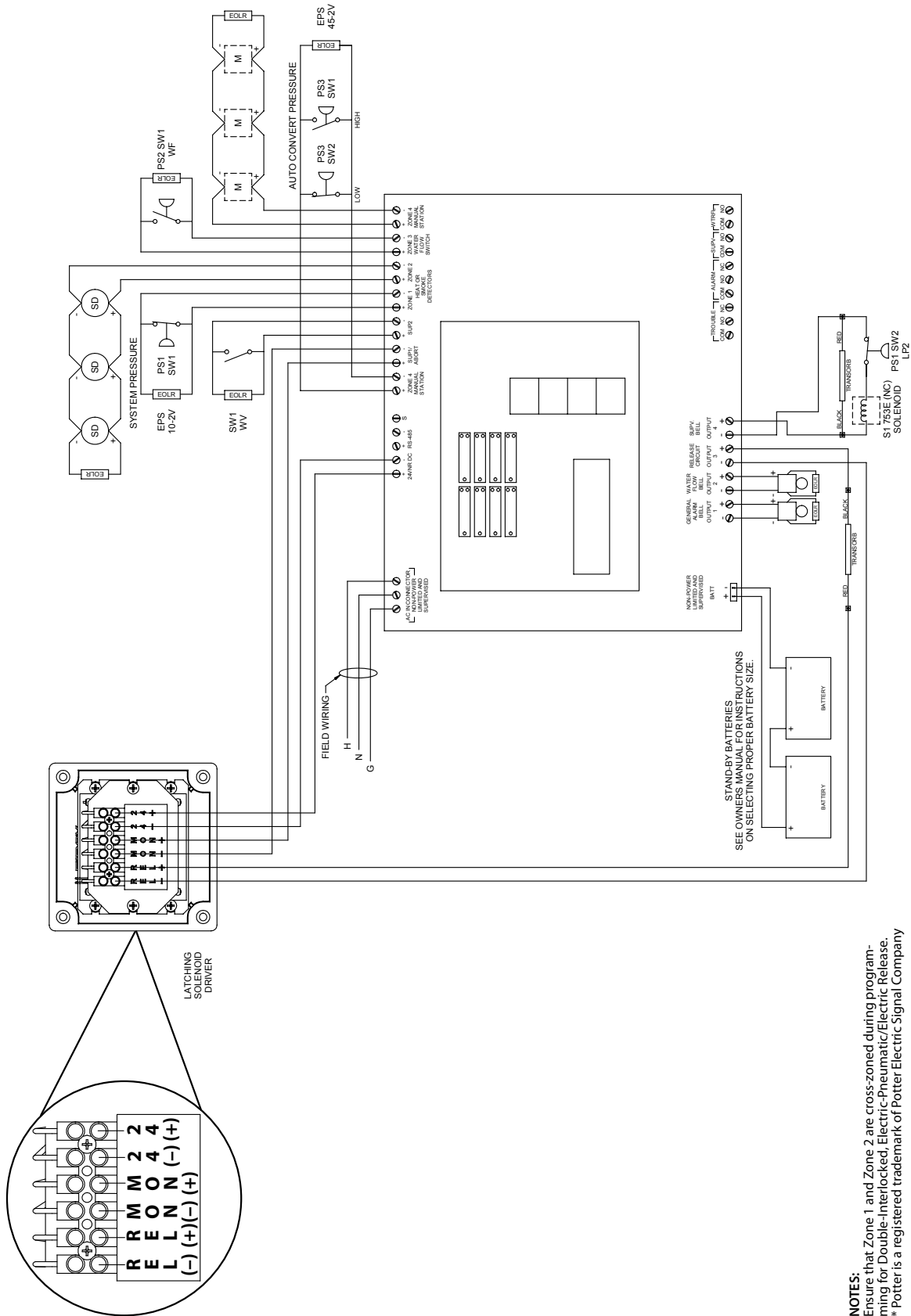

NOTES:
 Ensure that Zone 1 and Zone 2 are cross-zoned during programming for Double-Interlocked, Electric-Pneumatic/Electric Release.
 *Potter is a registered trademark of Potter Electric Signal Company

FireLock NXT™ AutoConvert Preaction Valve

SERIES 769

Preaction Electric AutoConvert Dry Trim

SAMPLE PROGRAM FOR SYSTEM SENSOR PDRP-2001 PANEL

SYSTEM SETUP

1. Enter programming mode
2. Down arrow to 3= SYSTEM SETUP
3. Select 2=TIMERS
4. Select 1=SOAK 1
5. Select 1=ALWAYS ON
6. Down arrow to screen 2 TIMERS
7. 1=AC LOSS DELAY, set to 0
8. Return to main menu PROGRAMMING
5. Select 2=ZONE 2
6. Go to EDIT mode and set the following
1=ENABLED
2=TYPE SUPERVSRV AR
3=OUTPUT CIRCUIT MAP
7. Press ↓, 2=DESCRIPTION
8. Type "CONVERT PRESSURE"
9. Return to INPUT ZONES

OUTPUT CIRCUITS

1. Select 3=OUTPUT CIRCUITS
2. Select 1=OUTPUT 1
3. Set to the following
1=ENABLED YES
2=TYPE ALARM NAC
4. Return to OUTPUT CIRCUITS
5. Select 2=OUTPUT 2
6. Set to the following
1=ENABLED YES
2=TYPE RELEASE CIR 1 UPSUPV SHORTS
7. Return to OUTPUT CIRCUITS
8. Select 3=OUTPUT 3
9. Set to the following
1=ENABLED YES
2=TYPE SUPV BELL NAC
10. Return to OUTPUT CIRCUITS, press ↓
11. Select 1=OUTPUT 4
12. Set to the following
1=ENABLED YES
2=TYPE TROUBLE BELL NAC
13. Return to main menu PROGRAMMING
10. Select 3=ZONE 3
11. Go to EDIT mode and set the following
1=ENABLED
2=TYPE WATERFLOW
3=OUTPUT CIRCUIT MAP
1=ALARM NAC YES
2=RELEASE 1 NO
12. Return to INPUT ZONES, press ↓
13. Select 1=ZONE 4
14. Go to EDIT mode and set the following
1=ENABLED
2=TYPE LOW PRESSURE AR
3=OUTPUT CIRCUIT MAP
15. Return to INPUT ZONES, press ↓
16. Select 2=ZONE 5
17. Go to EDIT mode and set the following
1=ENABLED
2=TYPE SUPERVSRV AR
3=OUTPUT CIRCUIT MAP
18. Press ↓, 2=DESCRIPTION
19. Type "WATER VALVE OFF"
20. Return to INPUT ZONES, press ↓
21. Select 3=ZONE 6
22. Go to EDIT mode and set the following
1=ENABLED
2=TYPE SUPERVSRV AR
3=OUTPUT CIRCUIT MAP
23. Press ↓, 2=DESCRIPTION
24. Type "CONVERT MODULE FAULT"
25. Press "ESC" several times to end

INPUT ZONES

1. Select 2= INPUT ZONES
2. Select 1=ZONE 1
3. Go to EDIT mode and set the following
1=ENABLED
2=TYPE 2-WIRE SMOKE
3=OUTPUT CIRCUIT MAP
1=ALARM NAC YES
2=RELEASE 1 YES
4. Return to INPUT ZONES

FireLock NXT™ AutoConvert Preaction Valve

SERIES 769

Preaction Electric AutoConvert Dry Trim

SAMPLE PROGRAM FOR POTTER SIGNAL PFC-4410RC PANEL

1. Push Run/Program switch down to PROGRAM
2. Press Function key until "Password=000" is displayed
3. Press Set key three times
"Init Zone #1 Enabled" is then displayed
4. Press Function key until "Unit Program #" is displayed
5. Press Select key until display shows "Program # 0"
6. Press Set key
7. Press Function key until "Init Zone #1" is displayed
8. Press Select key until "Low Air Alarm" is displayed (System)
9. Press Set key
"Init Zone #2" is displayed
10. Use Select and Set keys to select "Detection" for Zone 2
"Init Zone #3" is displayed
11. Use Select and Set keys to select "Water Flow" for Zone 3
"Init Zone #4" is displayed
12. Use Select and Set keys to select "Low Air Alarm" for Zone 4
(Auto Convert)
13. Use Select and Set keys to select "Supervisory" for Supervisory 1
Zone
14. Use Select and Set keys to select "Valve Tamper" for Supervisory
2 Zone
15. "Output #1" is displayed; use Select and Set keys to select
"Supervisory Bell"
16. "Output #2" is displayed; use Select and Set keys to select
"Indicating" (Alarm Bell)
17. "Output #3" is displayed; use Select and Set keys to select
"Trouble Bell"
18. "Output #4" is displayed; use Select and Set keys to select
"Releasing"
19. Push Program/Run Switch up to RUN if no other options are need-
ed (refer to programming manual provided with panel)

FireLock NXT™ AutoConvert Preaction Valve

SERIES 769

Preaction Electric AutoConvert Dry Trim

PLACING THE SYSTEM IN SERVICE

CAUTION

- Make sure the Series 769 FireLock NXT Preaction Valve is properly heated and protected from freezing temperatures and physical damage.

Failure to follow this instruction could cause improper valve operation, resulting in personal injury and/or property damage.

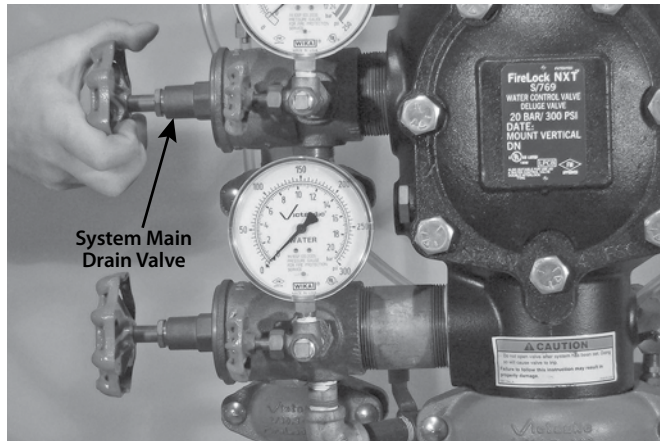

1. Open the system main drain valve. Confirm that the system is drained.

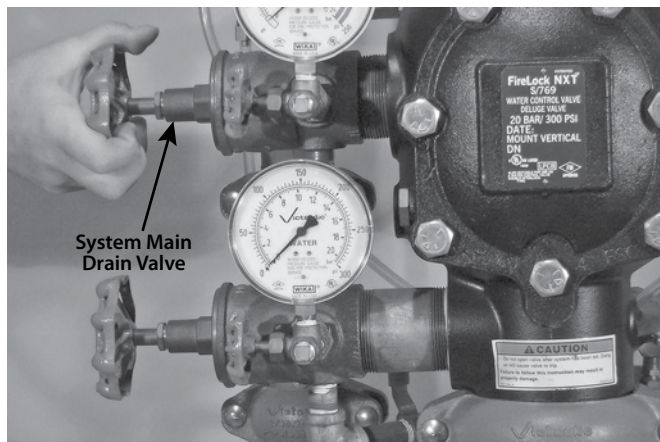

2. Close the system main drain valve.
3. Confirm that all system drains are shut and that the system is free of leaks.
- 3a. Confirm that the system has been depressurized. The gauges should indicate zero pressure.

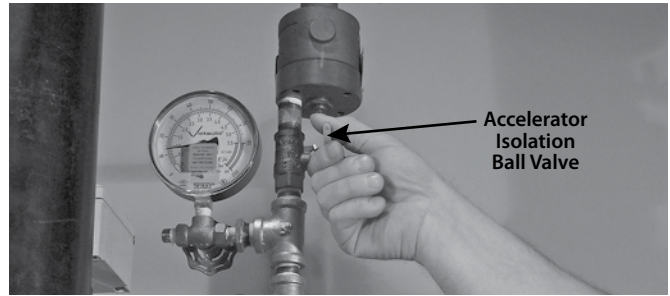

4. **FOR SYSTEMS INSTALLED WITH A SERIES 746-LPA DRY ACCELERATOR:** Confirm that the isolation ball valve to the accelerator is closed.

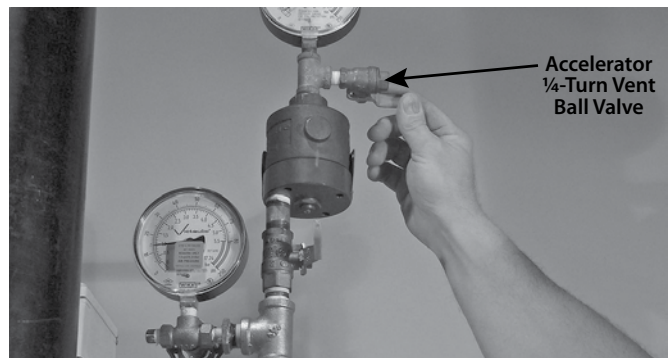

- 4a. **FOR SYSTEMS INSTALLED WITH A SERIES 746-LPA DRY ACCELERATOR:** Open the 1/4-turn vent ball valve.

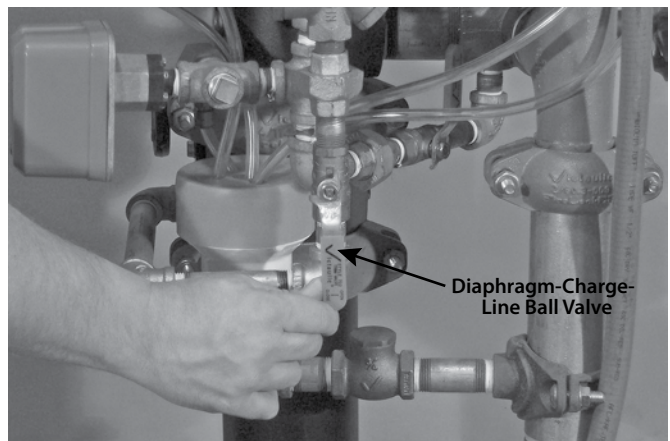

5. Open the diaphragm-charge-line ball valve.

FireLock NXT™ AutoConvert Preaction Valve

SERIES 769

Preaction Electric AutoConvert Dry Trim

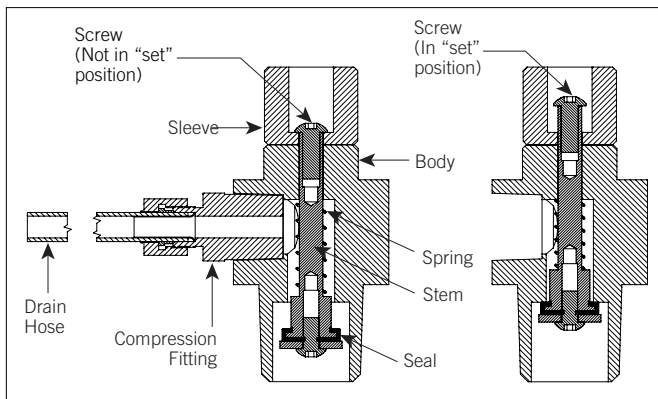
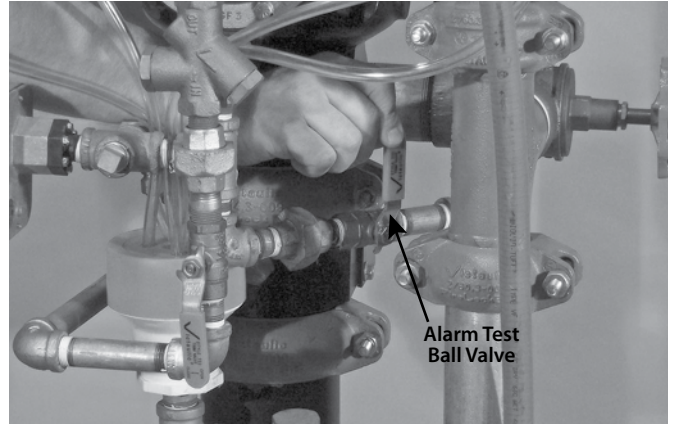
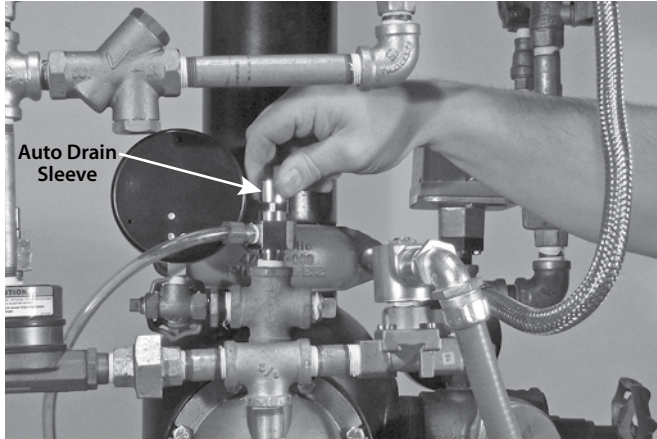

6. Confirm that water is flowing steadily from the Auto Drain. Pull up on the Auto Drain Sleeve.
- 6a. Confirm that water is flowing through the Series 776 Low-Pressure Actuator after opening the diaphragm-charge-line ball valve and pulling up on the Auto Drain Sleeve.
- 6b. Make sure no water flows through the solenoid after opening the diaphragm-charge-line ball valve. DO NOT pull up on the Auto Drain Sleeve.

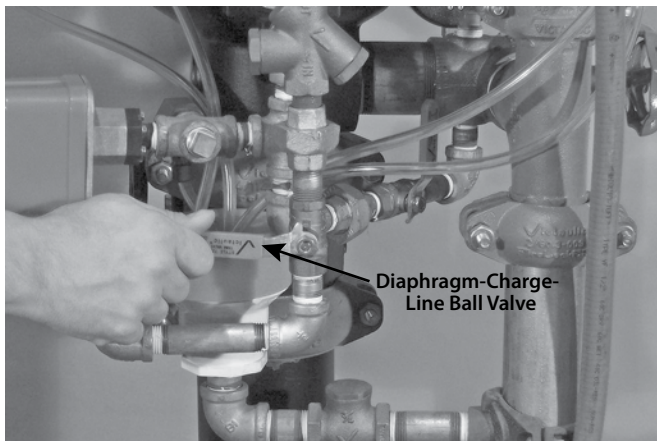

7. Close the diaphragm-charge-line ball valve.

8. Confirm that the alarm test ball valve is closed.

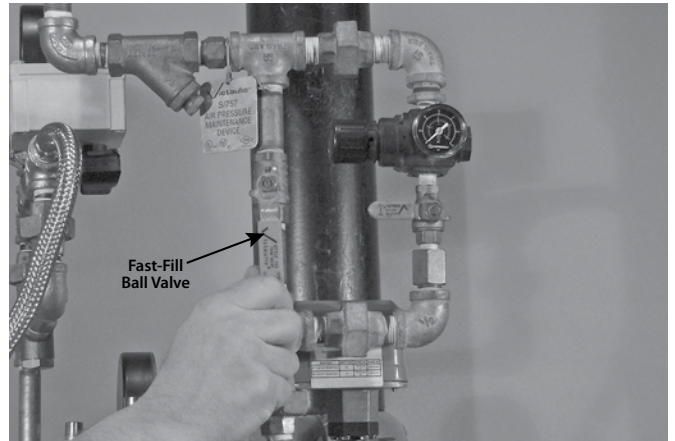

9. Charge the system with air by turning on the compressor or by opening the fast-fill ball valve on the AMTA (fast-fill ball valve is shown above). Charge the system to 13 psi/0.9 Bar minimum. Refer to the "Air Supply Requirements" section.
10. Confirm that the system is charging by observing the system air pressure gauge. If the gauge is not showing an increase in air pressure, there is a leak or an opening in the line. Repair any leaks or openings and restart the setup procedures.
11. Confirm that no water is being exhausted from the Auto Vent of the Series 776 Low-Pressure Actuator. If water is being exhausted from the Auto Vents, continue to run air through the system in order to remove moisture from the upper chamber of the Series 776 Low-Pressure Actuator. If a Series 746-LPA Dry Accelerator is installed, make sure the accelerator is not flooded.

FireLock NXT™ AutoConvert Preaction Valve

SERIES 769

Preaction Electric AutoConvert Dry Trim

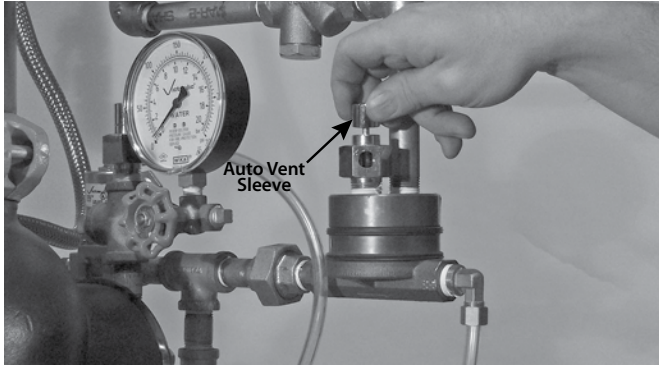

12. When the system reaches approximately 10 psi/0.7 Bar, and no additional moisture is being released from the Auto Vent, pull up on the Auto Vent Sleeve of the Series 776 Low-Pressure Actuator. **NOTE:** The Auto Vent Screw should seal and remain in the set ("UP") position.
13. Confirm that the solenoid is closed.

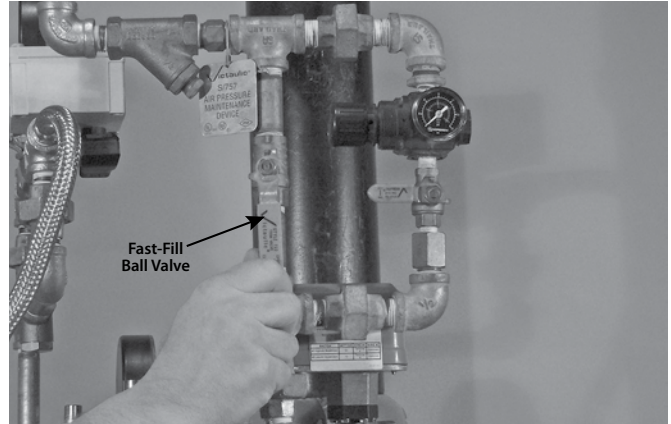

16. Re-charge the system with air by turning on the compressor or by opening the fast-fill ball valve on the AMTA (fast-fill ball valve is shown above). Charge the system to 13 psi/0.9 Bar minimum.

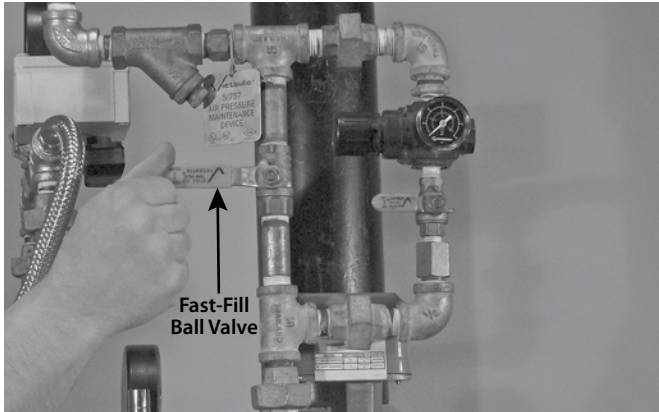

14. When system air pressure is established, close the fast-fill ball valve on the AMTA.

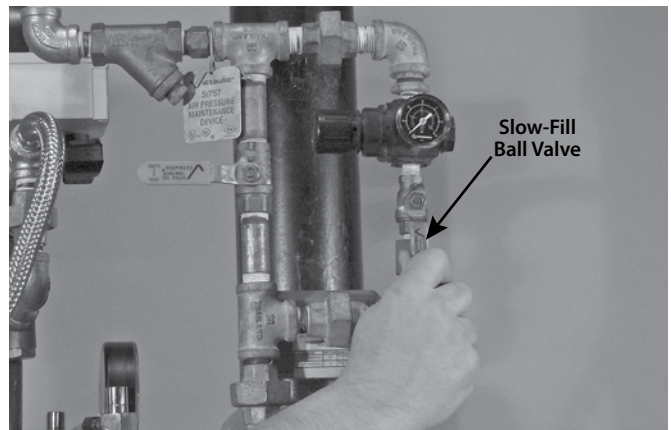

17. Open the slow-fill ball valve on the AMTA. **NOTE:** Failure to leave the slow-fill ball valve open may allow system pressure to drop, resulting in valve operation in the event of a system leak.

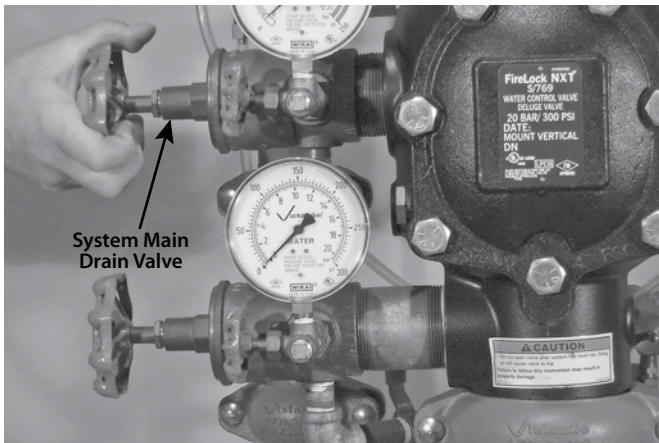

15. Open the system main drain valve slightly to lower the system air pressure approximately 3 to 5 psi/0.2 - 0.3 Bar. **DO NOT** drop the system air pressure below 10 psi/0.7 Bar.
- 15a. Make sure the AutoConvert Assembly Air Pressure Gauge (Item 28 on page 5) maintains the normal system air pressure and does not track the system air loss created in step 15.

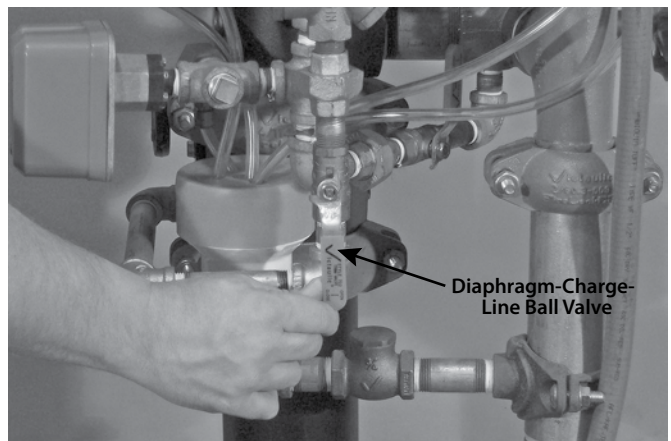

18. Open the diaphragm-charge-line ball valve. Allow water to flow through the Auto Drain tube.

FireLock NXT™ AutoConvert Preaction Valve

SERIES 769

Preaction Electric AutoConvert Dry Trim



19. Open the manual pull station to bleed off any air that is present.



20. Close the manual pull station.

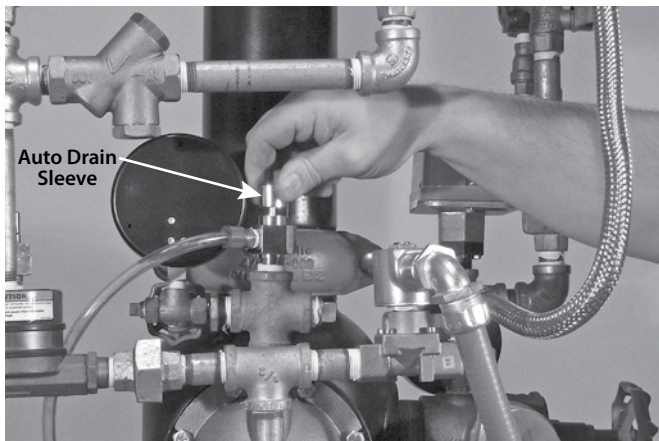

21. Pull up on the Auto Drain Sleeve until the screw is in the set ("UP") position. Verify that there is pressure on the gauge to the diaphragm charge line.

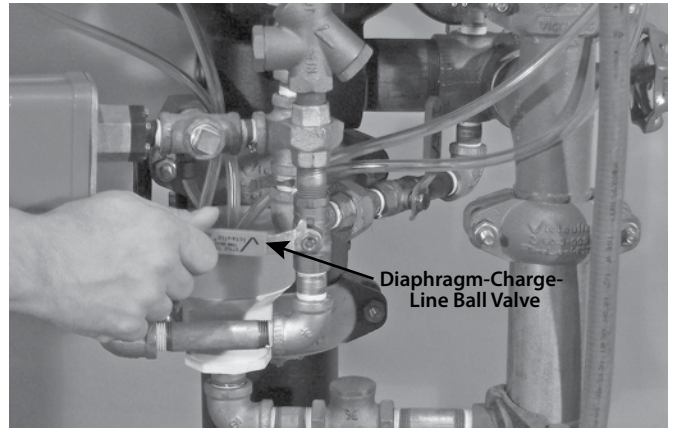

22. When the diaphragm charge line is pressurized, temporarily close the diaphragm-charge-line ball valve. Confirm that the diaphragm charge line is maintaining pressure by observing the diaphragm-charge-line pressure gauge.

22a. If pressure in the diaphragm charge line drops, the diaphragm must be replaced and/or any leaks in the diaphragm charge line must be corrected. Refer to the "Removing and Replacing the Diaphragm Assembly" section.

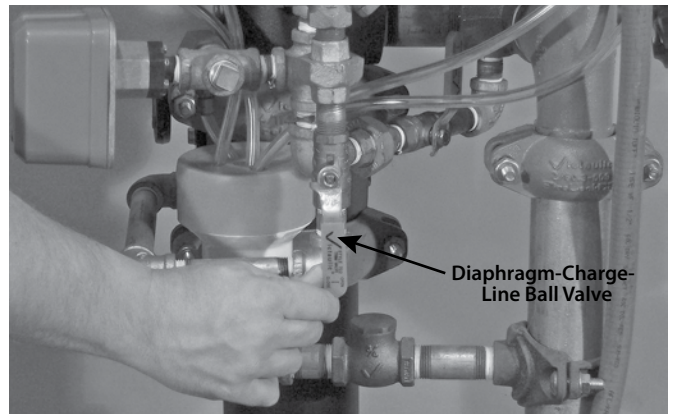

22b. If pressure in the diaphragm charge line does not drop, re-open the diaphragm-charge-line ball valve, and proceed to the following step.

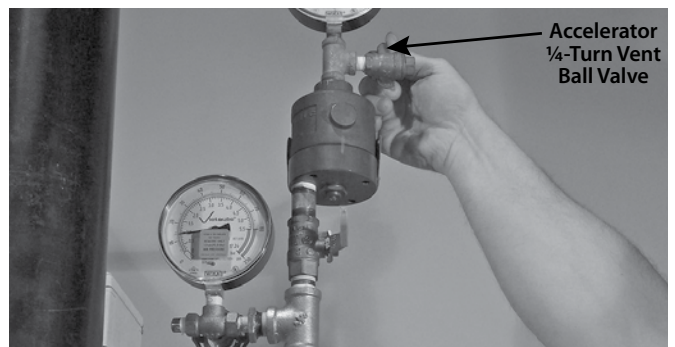

23. **FOR SYSTEMS INSTALLED WITH A SERIES 746-LPA DRY ACCELERATOR:** Close the 1/4-turn vent ball valve on the accelerator.

FireLock NXT™ AutoConvert Preaction Valve

SERIES 769

Preaction Electric AutoConvert Dry Trim

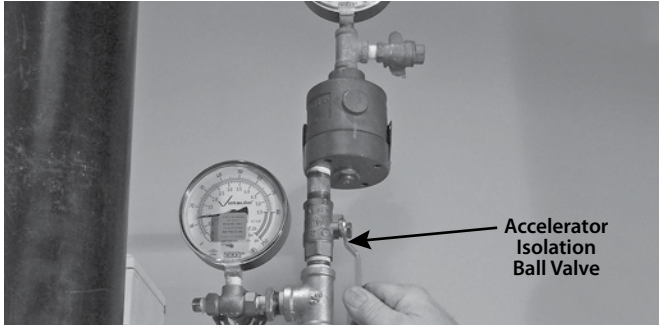

Accelerator Isolation Ball Valve

24. **FOR SYSTEMS INSTALLED WITH A SERIES 746-LPA DRY ACCELERATOR:** Open the isolation ball valve. This will set the accelerator.
25. Observe the system air pressure over a 24-hour period to confirm system integrity. If there is degradation in system air pressure, find and correct all leaks. **NOTE:** NFPA requires less than 1½-psi/ 0.1-Bar leakage in 24 hours.

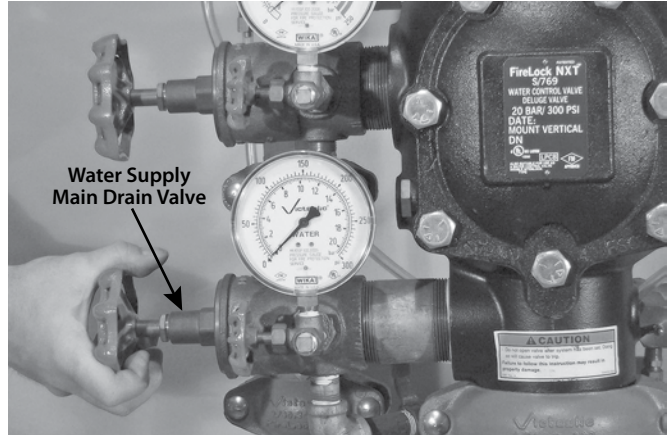

Water Supply Main Drain Valve

28. Close the water supply main drain valve when a steady flow of water occurs.

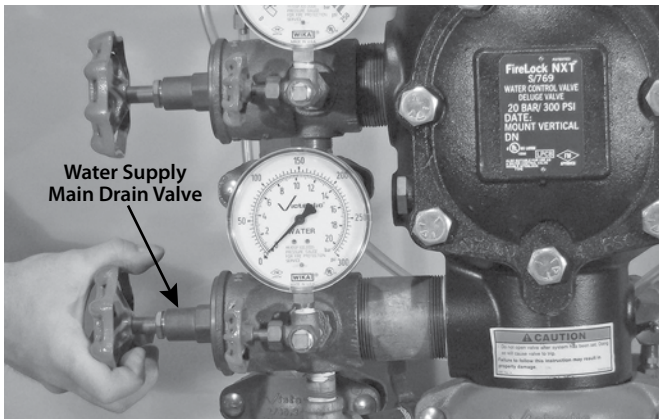

Water Supply Main Drain Valve

26. Open the water supply main drain valve.

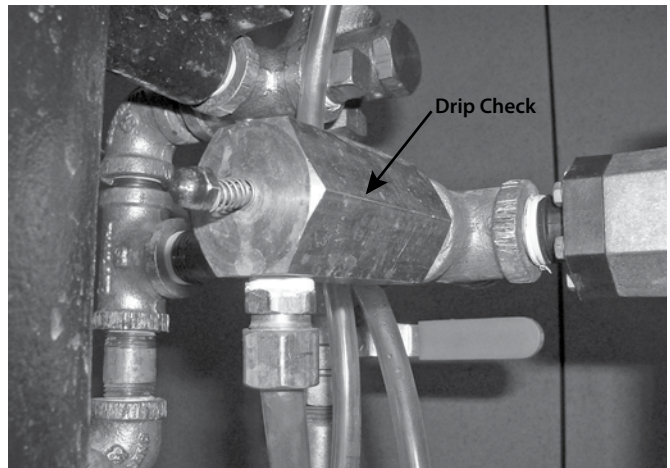

Drip Check

29. Confirm that there is no leakage from the intermediate valve chamber. The drip check in the alarm line should not be leaking water or air.

<p>⚠ CAUTION</p>
<ul style="list-style-type: none"> Take precautions when opening the water supply main control valve, since water will flow from all open system valves. Failure to follow this instruction could result in property damage.

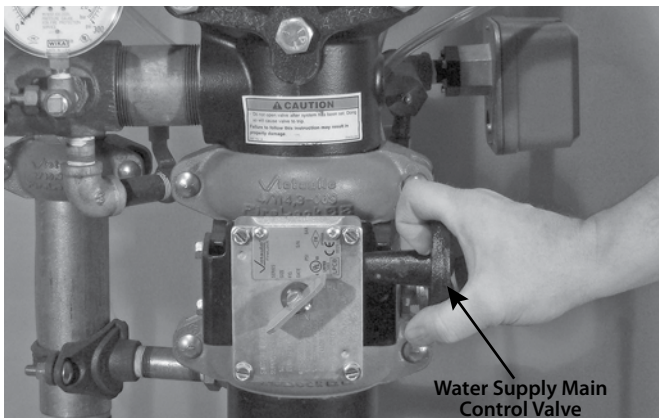

Water Supply Main Control Valve

27. Open the water supply main control valve slowly until water flows steadily from the open water supply main drain valve.

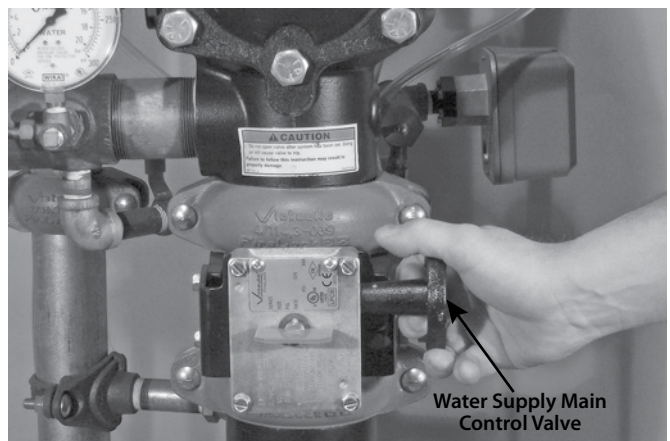

Water Supply Main Control Valve

30. If water or air is flowing from the drip check, close the water supply main control valve, and start over at step 1. Refer to the "Troubleshooting" section.

FireLock NXT™ AutoConvert Preaction Valve

SERIES 769

Preaction Electric AutoConvert Dry Trim

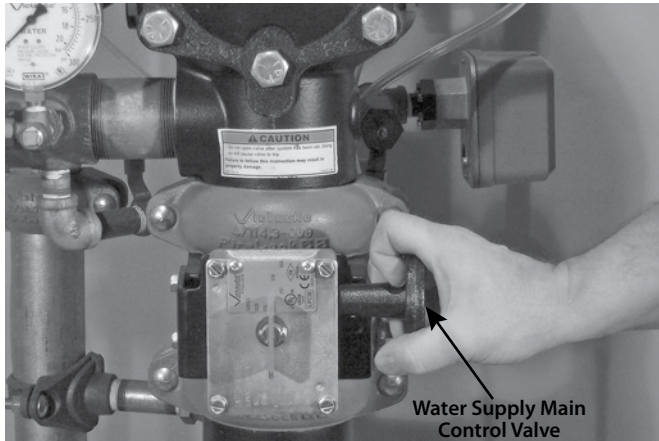

31. Open the water supply main control valve fully.
32. Record the system air pressure and the water supply pressure.
33. Confirm that all valves are in their normal operating positions (refer to the table below).

Valve	Normal Operating Position
Diaphragm-Charge-Line Ball Valve	Open
Alarm Test Ball Valve	Closed
Water Supply Main Control Valve	Open
Water Supply Main Drain Valve	Closed
System Main Drain Valve	Closed
Slow-Fill Ball Valve of the Victaulic AMTA (if applicable)	Open
Fast-Fill Ball Valve of the Victaulic AMTA (if applicable)	Closed
Isolation Ball Valve for Series 746-LPA Dry Accelerator (if applicable)	Open
¼-Turn Vent Ball Valve for Series 746-LPA Dry Accelerator (if applicable)	Closed

34. Notify the authority having jurisdiction, remote station alarm monitors, and those in the affected area that the system is in service.

ON A WEEKLY BASIS, WHEN THE VALVE IS RESET AFTER AN OPERATIONAL TEST (OR AFTER ANY SYSTEM OPERATION): The main drain valve and any low-point drain valves should be partially opened and then closed to drain water that might be present in the riser. Continue this procedure until all water is released. **NOTE:** The optional Series 75D Water Column Kit can be installed to automate this step.

NOTICE

- If the main drain valve is open for a prolonged period of time, the system air pressure may be lowered to a point where the preaction valve will operate.

FireLock NXT™ AutoConvert Preaction Valve

SERIES 769

Preaction Electric AutoConvert Dry Trim

EXTERNAL INSPECTION

WARNING

- The building owner or their representative is responsible for maintaining the fire protection system in proper operating condition.
 - To ensure proper system operation, valves must be inspected in accordance with current NFPA-25 requirements or in accordance with the requirements of the local authority having jurisdiction (whichever is more stringent). Always refer to the instructions in this manual for additional inspection and testing requirements.
 - The frequency of inspections must be increased in the presence of contaminated water supplies, corrosive/scaling water supplies, and corrosive atmospheres.
 - Depressurize and drain the piping system before attempting to install, remove, adjust, or maintain any Victaulic products.
- Failure to follow these instructions could cause system failure, resulting in death, serious personal injury, and property damage.

NOTICE

- Any activities that require taking the valve out of service may eliminate the fire protection provided.
- Consideration of a fire patrol should be given for the affected areas.
- Before servicing or testing the system, notify the authority having jurisdiction.

WEEKLY INSPECTION

1. Perform a visual inspection on the valve and trim on a weekly basis. **NOTE:** If the preaction system is equipped with a low-pressure alarm, monthly inspections may be sufficient. Contact the local authority having jurisdiction for specific requirements.

MONTHLY INSPECTION

1. Record the system air pressure and water supply pressure. Confirm that the water supply pressure is within the range of normal pressures observed in the area. Significant loss of water supply pressure could indicate an adverse condition in the water supply.

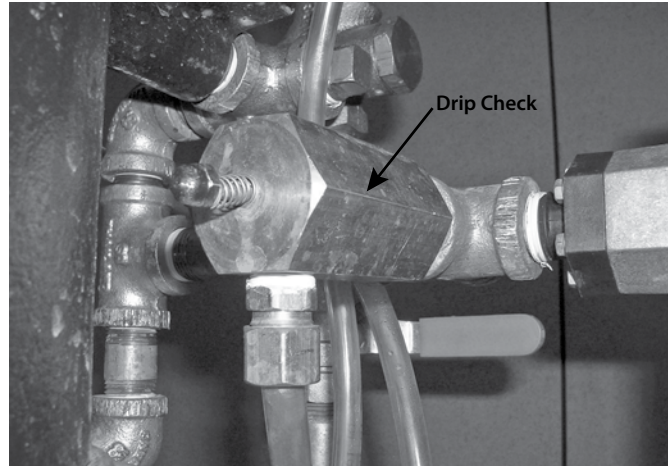

2. Confirm that there is no leakage from the intermediate valve chamber. The drip check in the alarm line should not be leaking water or air.
3. Inspect the valve and trim for mechanical damage and corrosion. Replace any damaged or corroded parts.
4. Confirm that the preaction valve and trim are located in an area that is not subject to freezing temperatures.
5. Confirm that all valves are in their normal operating positions (refer to the table below).

Valve	Normal Operating Position
Diaphragm-Charge-Line Ball Valve	Open
Alarm Test Ball Valve	Closed
Water Supply Main Control Valve	Open
Water Supply Main Drain Valve	Closed
System Main Drain Valve	Closed
Slow-Fill Ball Valve of the Victaulic AMTA (if applicable)	Open
Fast-Fill Ball Valve of the Victaulic AMTA (if applicable)	Closed
Isolation Ball Valve for Series 746-LPA Dry Accelerator (if applicable)	Open
¼-Turn Vent Ball Valve for Series 746-LPA Dry Accelerator (if applicable)	Closed

6. If a Series 746-LPA Dry Accelerator is installed, record the pressure in the air chamber of the dry accelerator. The pressure in the air chamber should equal the system air pressure within the allowable tolerances of the gauges. If the air chamber's pressure is below the system air pressure, follow the "Troubleshooting" section.

FireLock NXT™ AutoConvert Preaction Valve

SERIES 769

Preaction Electric AutoConvert Dry Trim

REQUIRED TESTS

⚠ WARNING

- The building owner or their representative is responsible for maintaining the fire protection system in proper operating condition.
- To ensure proper system operation, valves must be inspected in accordance with current NFPA-25 requirements or in accordance with the requirements of the local authority having jurisdiction (whichever is more stringent). Always refer to the instructions in this manual for additional inspection and testing requirements.
- The frequency of inspections must be increased in the presence of contaminated water supplies, corrosive/scaling water supplies, and corrosive atmospheres.
- Depressurize and drain the piping system before attempting to install, remove, adjust, or maintain any Victaulic products.

Failure to follow these instructions could cause system failure, resulting in death, serious personal injury, and property damage.

NOTICE

- Any activities that require taking the valve out of service may eliminate the fire protection provided.
- Consideration of a fire patrol should be given for the affected areas.
- Before servicing or testing the system, notify the authority having jurisdiction.

MAIN DRAIN TEST

Perform the main drain test on a frequency required by the current NFPA-25 code. The authority having jurisdiction in the area may require these tests on a more frequent basis. Verify these requirements by contacting the authority having jurisdiction in the affected area.

1. Notify the authority having jurisdiction, remote station alarm monitors, and those in the affected area that the main drain test will be performed.
2. Confirm that sufficient drainage is available.
3. Record the water supply pressure and system air pressure.

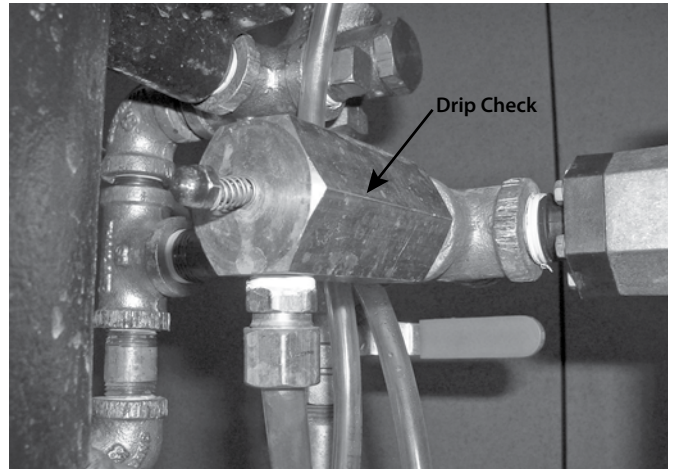

4. Confirm that there is no leakage from the intermediate valve chamber. The drip check in the alarm line should not be leaking water or air.
5. Verify that the system is at the proper air pressure for the local water supply pressure.

⚠ CAUTION

- Use caution to prevent opening the system main drain valve accidentally.
- Opening the system main drain valve will cause the valve to operate, resulting in property damage.

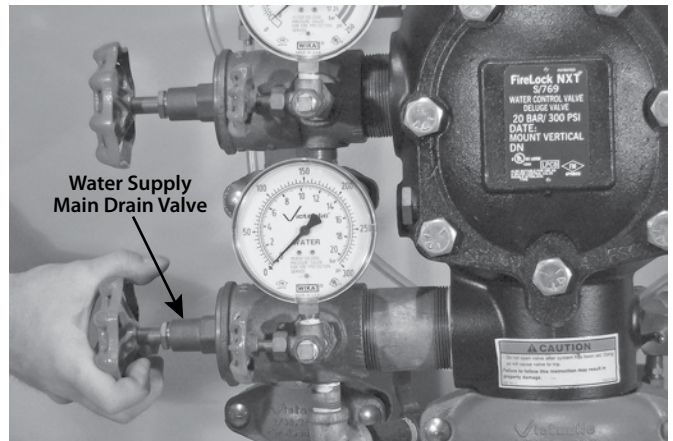

6. Open the water supply main drain valve fully to flush the water supply of any contaminants.
7. While the water supply main drain valve is fully open, record the water supply pressure (from the water supply gauge) as the residual pressure.

FireLock NXT™ AutoConvert Preaction Valve

SERIES 769

Preaction Electric AutoConvert Dry Trim

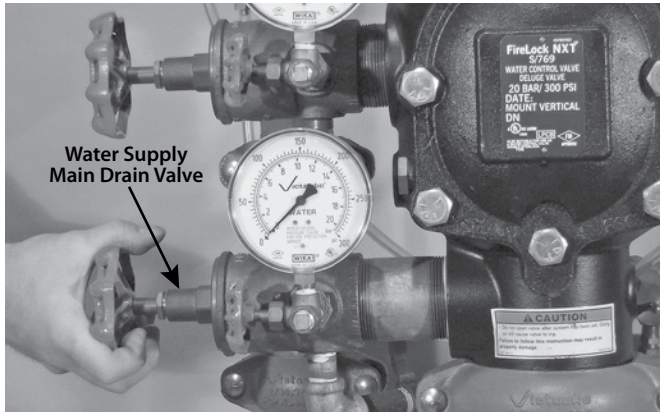

8. Close the water supply main drain valve slowly.
9. Record the water pressure established after closing the water supply main drain valve.
10. Compare the residual pressure reading, taken above, to the residual pressure readings taken in previous main drain tests. If there is degradation in the residual water supply reading, restore the proper water supply pressure.
11. Confirm that all valves are in their normal operating positions (refer to the table below).

Valve	Normal Operating Position
Diaphragm-Charge-Line Ball Valve	Open
Alarm Test Ball Valve	Closed
Water Supply Main Control Valve	Open
Water Supply Main Drain Valve	Closed
System Main Drain Valve	Closed
Slow-Fill Ball Valve of the Victaulic AMTA (if applicable)	Open
Fast-Fill Ball Valve of the Victaulic AMTA (if applicable)	Closed
Isolation Ball Valve for Series 746-LPA Dry Accelerator (if applicable)	Open
¼-Turn Vent Ball Valve for Series 746-LPA Dry Accelerator (if applicable)	Closed

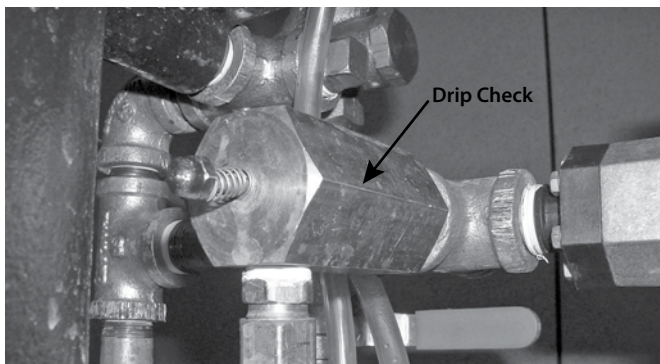

12. Confirm that there is no leakage from the intermediate valve chamber. The drip check in the alarm line should not be leaking water or air.
13. Notify the authority having jurisdiction, remote station alarm monitors, and those in the affected area that the valve is back in service.
14. Provide test results to the authority having jurisdiction, if required.

WATER FLOW ALARM TEST

Perform the water flow alarm test on a frequency required by the current NFPA-25 code. The authority having jurisdiction in the area may require these tests on a more frequent basis. Verify these requirements by contacting the authority having jurisdiction in the affected area.

1. Notify the authority having jurisdiction, remote station alarm monitors, and those in the affected area that the water flow alarm test will be performed.

⚠ CAUTION

- Use caution to prevent opening the system main drain valve accidentally.

Opening the system main drain valve will cause the valve to operate, resulting in property damage.

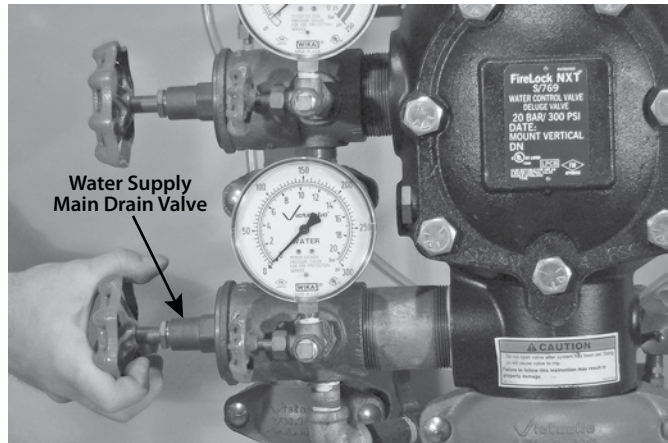

2. Open the water supply main drain valve fully to flush the water supply of any contaminants.

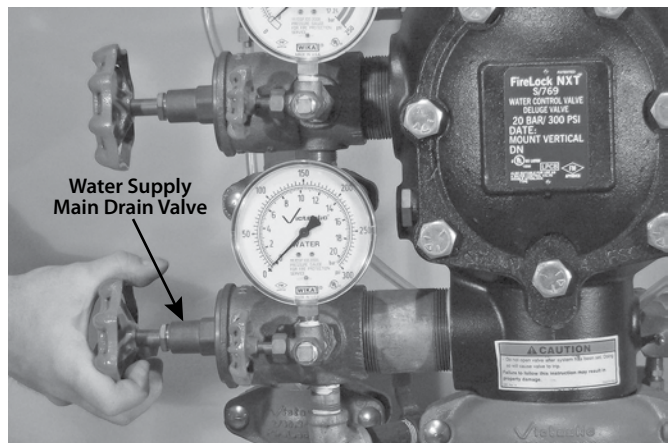

3. Close the water supply main drain valve.

FireLock NXT™ AutoConvert Preaction Valve

SERIES 769

Preaction Electric AutoConvert Dry Trim

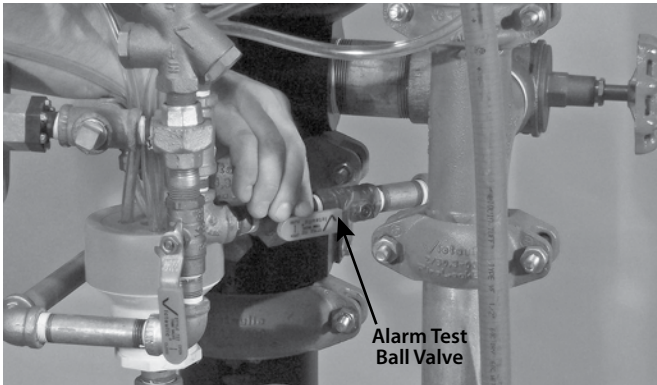

4. Open the alarm test ball valve. Confirm that mechanical and electrical alarms are activated and that remote monitoring stations, if provided, receive an alarm signal.

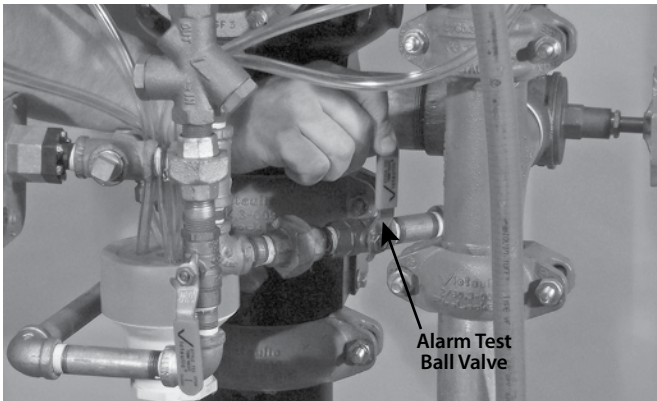

5. Close the alarm test ball valve after verifying proper operation of all alarms.

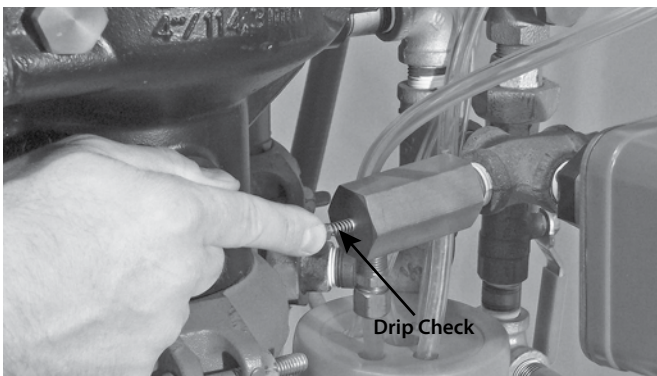

6. Push in the plunger of the drip check to verify that there is no pressure in the alarm line.
7. Verify that all alarms stopped sounding, that the alarm line drained properly, and that remote station alarms reset properly.
8. Confirm that there is no leakage from the intermediate valve chamber. The drip check in the alarm line should not be leaking water or air.
9. Notify the authority having jurisdiction, remote station alarm monitors, and those in the affected area that the valve is back in service.
10. Provide test results to the authority having jurisdiction, if required.

AUTOCONVERT SYSTEM TEST

Victaulic recommends the AutoConvert system test every year (at minimum).

1. Notify the authority having jurisdiction, remote station alarm monitors, and those in the affected area that the AutoConvert system test will be performed.

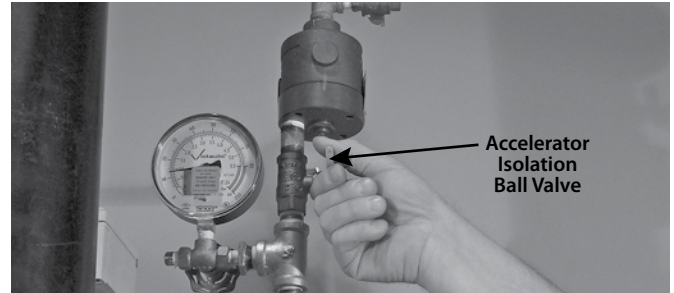

2. If a Series 746-LPA Dry Accelerator is installed, close the isolation ball valve.

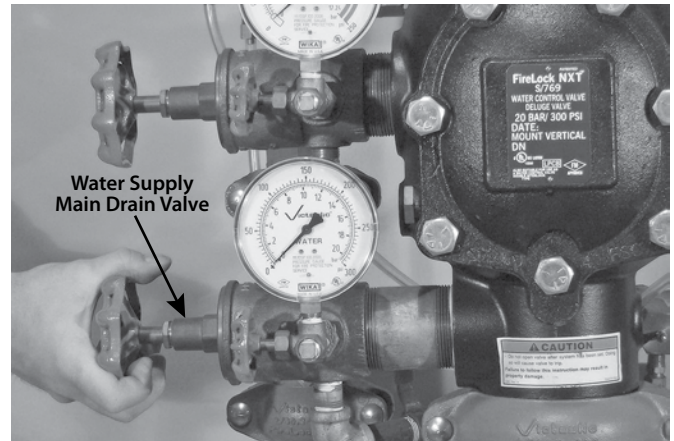

3. Open the water supply main drain valve fully to flush the water supply of any contaminants.

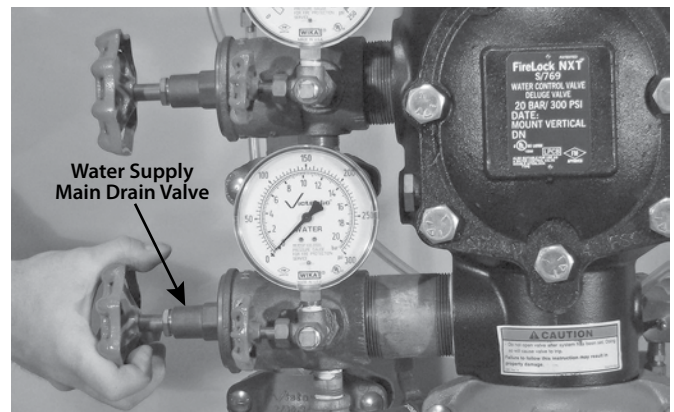

4. Close the water supply main drain valve.

FireLock NXT™ AutoConvert Preaction Valve

SERIES 769

Preaction Electric AutoConvert Dry Trim

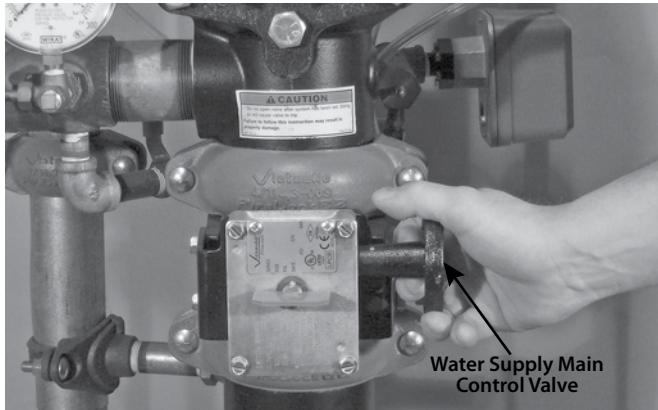

5. Close the water supply main control valve.

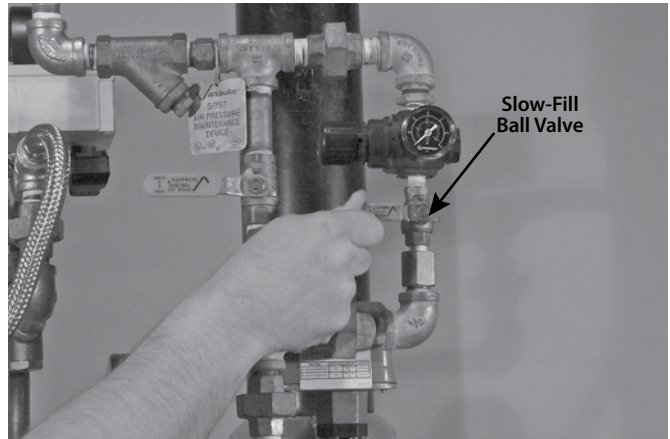

8. Close the slow-fill ball valve on the AMTA.

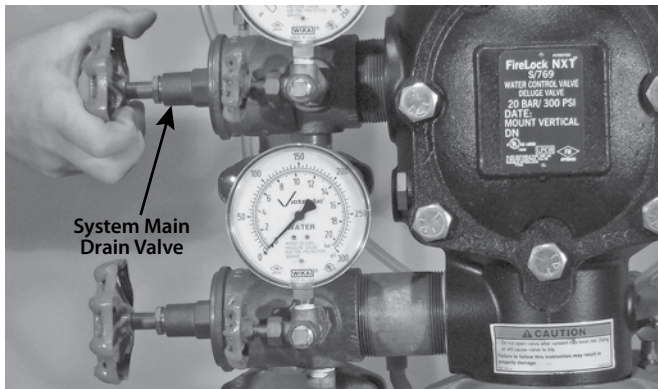

6. Open the system main drain valve slightly to lower the system air pressure approximately 3 to 5 psi/0.2 - 0.3 Bar. DO NOT drop the system air pressure below 10 psi/0.7 Bar.

6a. Make sure the AutoConvert Assembly Air Pressure Gauge (Item 34 on page 5) maintains pressure and does not track system air loss.

6b. Remove power from the FACP.

6c. Make sure the latching solenoid of the AutoConvert Trim Assembly opens. System air pressure decay (system pressure gauge, Item 17 on page 4) should track with the AutoConvert Assembly Air Pressure Gauge (Item 34 on page 5).

6d. Restore power to the FACP.

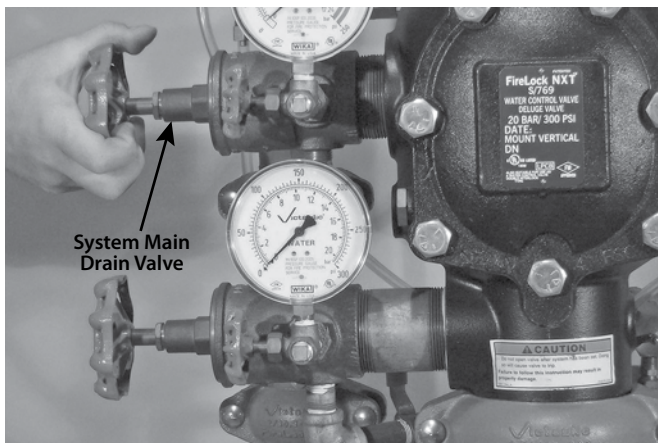

7. Close the system main drain valve.

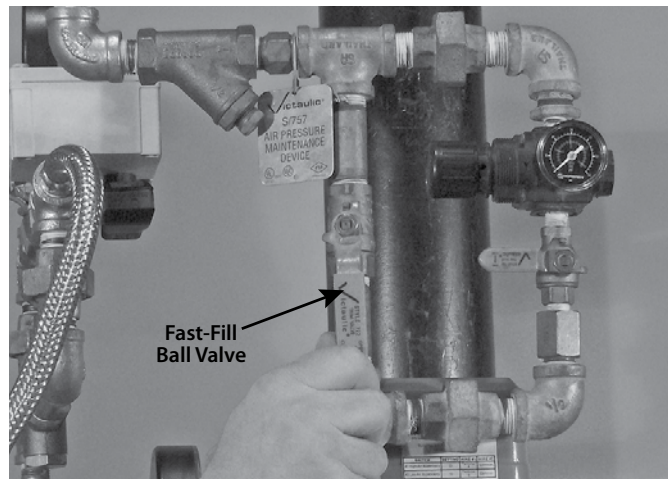

9. Open the fast-fill ball valve on the AMTA. Bring the pressure back up to the normal system pressure.

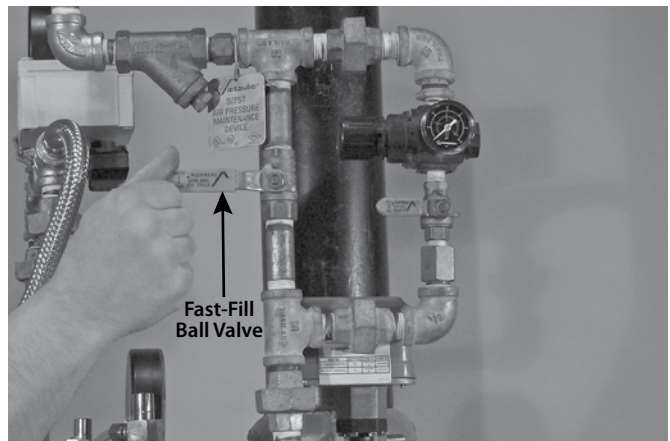

10. When the normal system air pressure is reached, close the fast-fill ball valve on the AMTA.

FireLock NXT™ AutoConvert Preaction Valve

SERIES 769

Preaction Electric AutoConvert Dry Trim

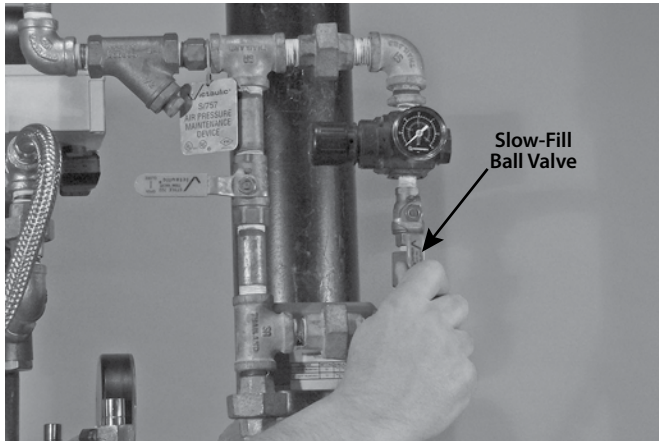

11. Open the slow-fill ball valve on the AMTA.

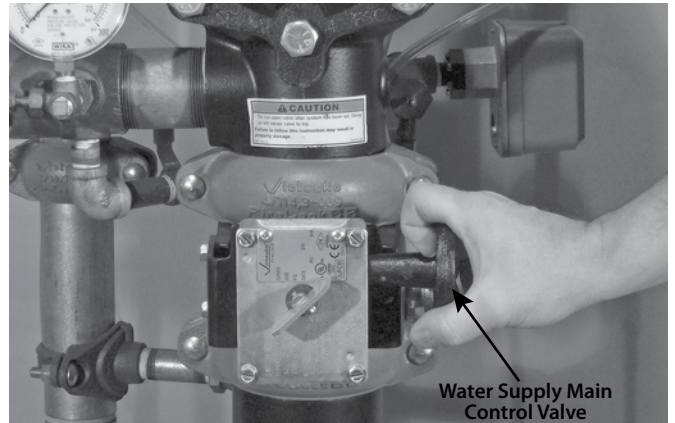

14. Open the water supply main control valve slowly until water flows steadily from the open water supply main drain valve.

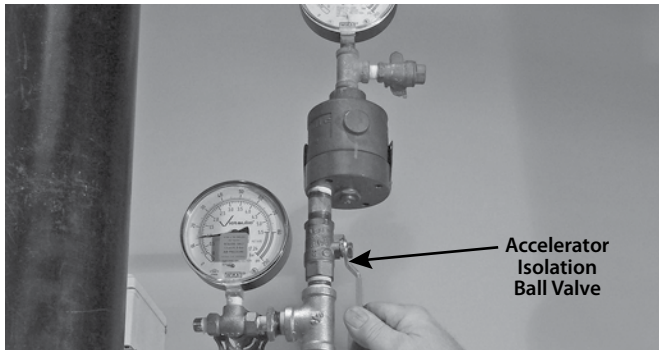

12. If a Series 746-LPA Dry Accelerator is installed, open the isolation ball valve.

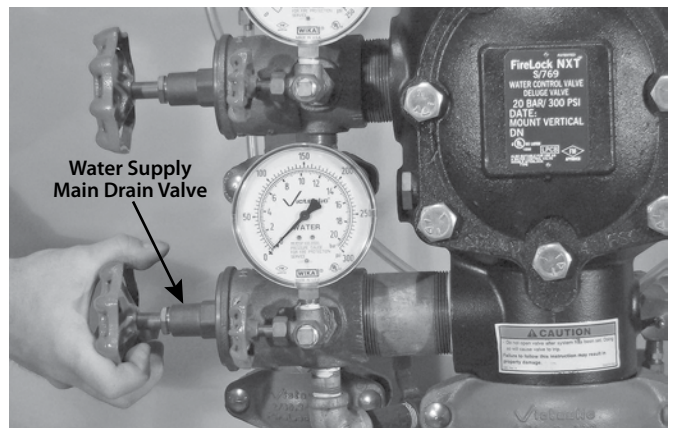

15. Close the water supply main drain valve when a steady flow of water occurs.

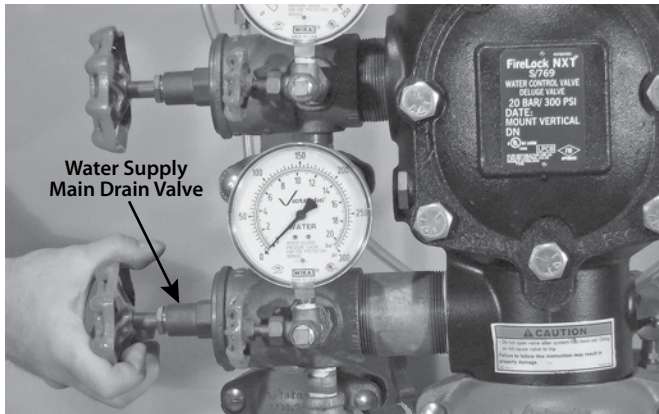

13. Open the water supply main drain valve.

CAUTION

- Take precautions when opening the water supply main control valve, since water will flow from all open system valves. Failure to follow this instruction could result in property damage.

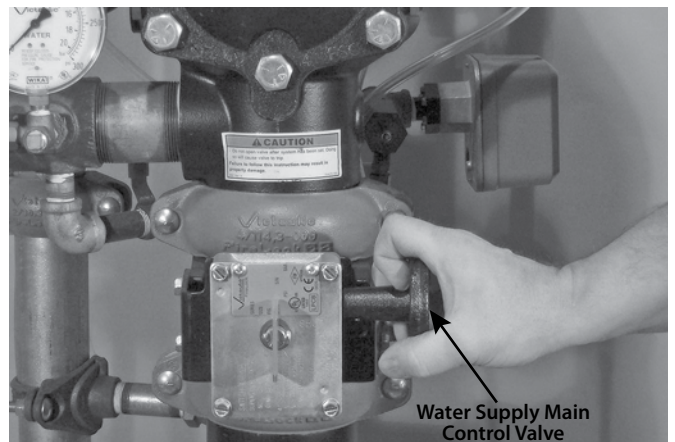

16. Open the water supply main control valve fully.

17. Confirm that all valves are in their normal operating positions (refer to the table on the following page).

FireLock NXT™ AutoConvert Preaction Valve

SERIES 769

Preaction Electric AutoConvert Dry Trim

Valve	Normal Operating Position
Diaphragm-Charge-Line Ball Valve	Open
Alarm Test Ball Valve	Closed
Water Supply Main Control Valve	Open
Water Supply Main Drain Valve	Closed
System Main Drain Valve	Closed
Slow-Fill Ball Valve of the Victaulic AMTA (if applicable)	Open
Fast-Fill Ball Valve of the Victaulic AMTA (if applicable)	Closed
Isolation Ball Valve for Series 746-LPA Dry Accelerator (if applicable)	Open
¼-Turn Vent Ball Valve for Series 746-LPA Dry Accelerator (if applicable)	Closed

- Notify the authority having jurisdiction, remote station alarm monitors, and those in the affected area that the valve is back in service.
- Provide test results to the authority having jurisdiction, if required.

WATER LEVEL AND LOW AIR ALARM TESTS

Perform the water level and low air alarm tests on a frequency required by the current NFPA-25 code. The authority having jurisdiction in the area may require these tests on a more frequent basis. Verify these requirements by contacting the authority having jurisdiction in the affected area.

NOTICE

- If a Series 746-LPA Dry Accelerator is installed, make sure the authority having jurisdiction is notified that the water level and low air alarm tests are in progress. Failure to close the isolation ball valve of the Series 746-LPA Dry Accelerator may cause the valve to trip, resulting in a false alarm.

- Notify the authority having jurisdiction, remote station alarm monitors, and those in the affected area that the water level and low air alarm tests will be performed.

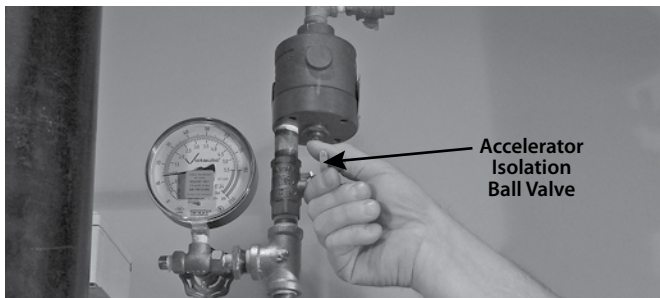

- If a Series 746-LPA Dry Accelerator is installed, close the isolation ball valve.

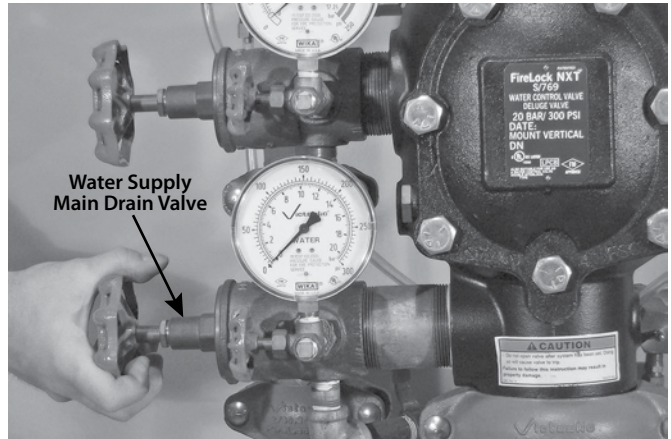

- Open the water supply main drain valve fully to flush the water supply of any contaminants.

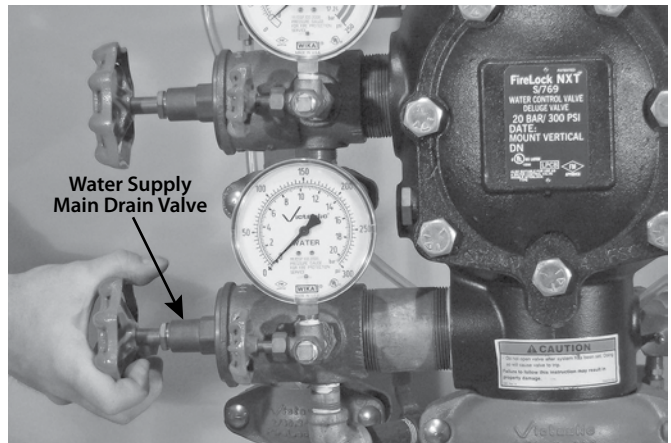

- Close the water supply main drain valve.

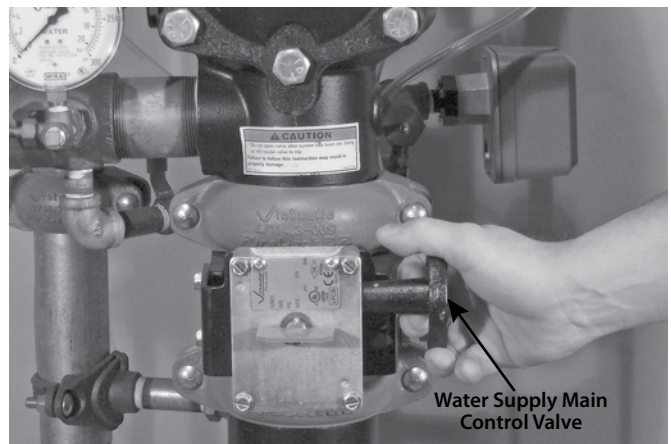

- Close the water supply main control valve.

FireLock NXT™ AutoConvert Preaction Valve

SERIES 769

Preaction Electric AutoConvert Dry Trim

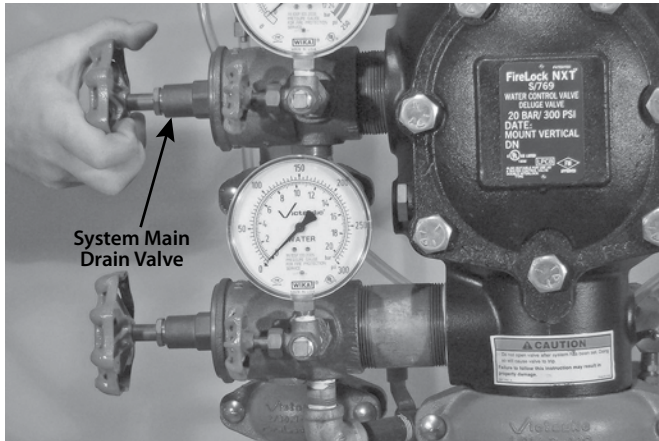

6. Partially open the system main drain valve slowly. Confirm that water is not flowing from the drain. **NOTE:** If water is flowing from the drain, the system may not have drained properly. In this case, follow all steps under the “Placing the System in Service” section.
7. Record the system air pressure at which the low air alarm activates.

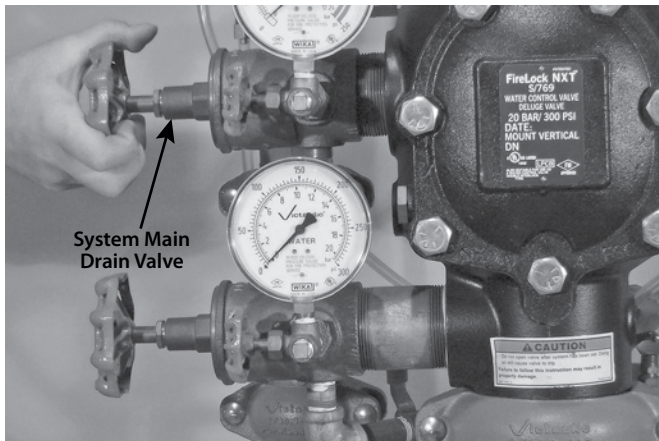

8. Close the system main drain valve.

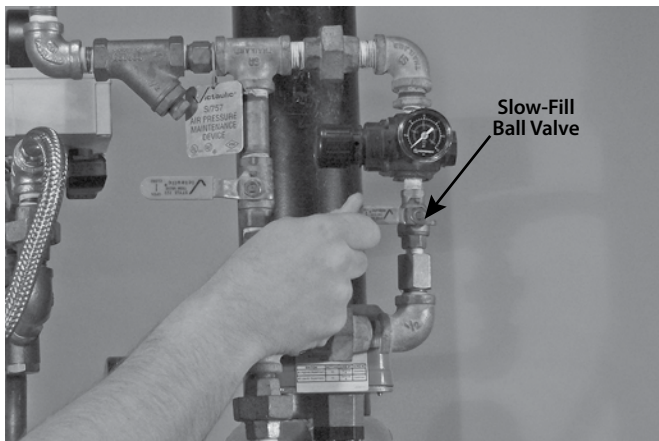

9. Close the slow-fill ball valve on the AMTA.

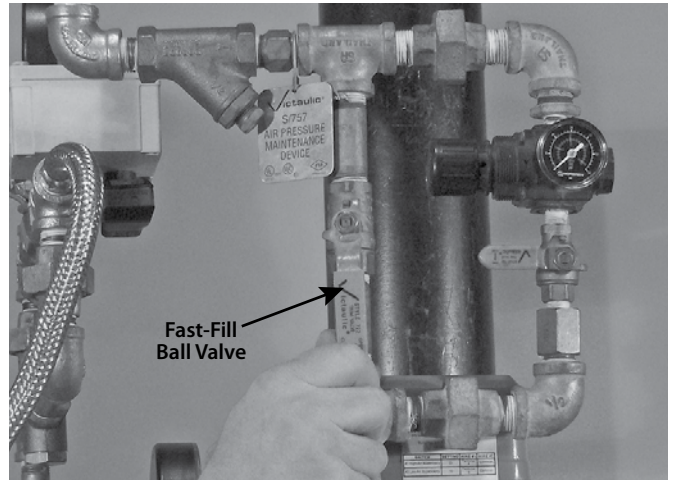

10. Open the fast-fill ball valve on the AMTA. Bring the pressure back up to the normal system pressure.

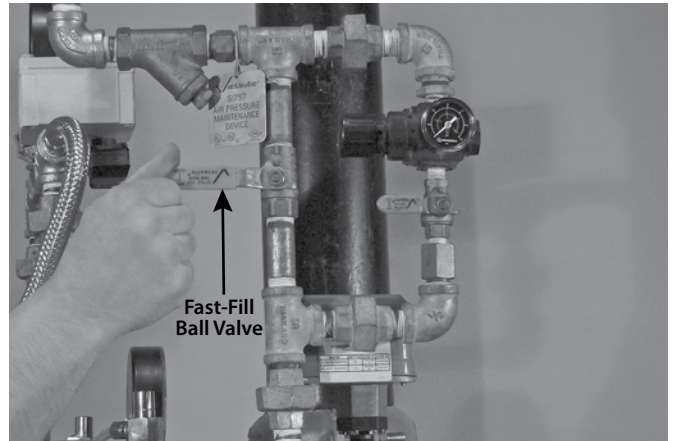

11. When the normal system air pressure is reached, close the fast-fill ball valve on the AMTA.

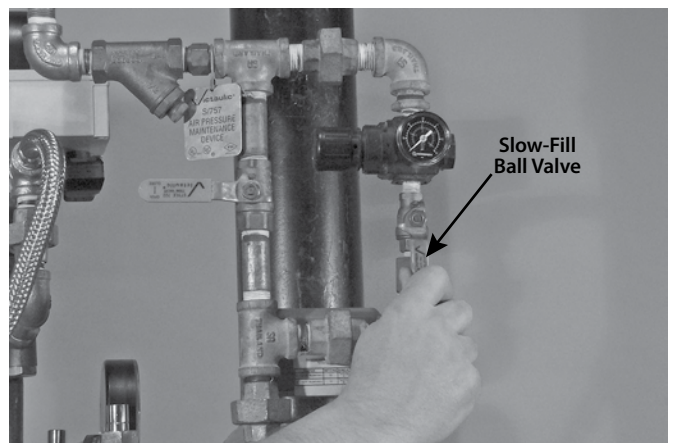

12. Open the slow-fill ball valve on the AMTA.

FireLock NXT™ AutoConvert Preaction Valve

SERIES 769

Preaction Electric AutoConvert Dry Trim

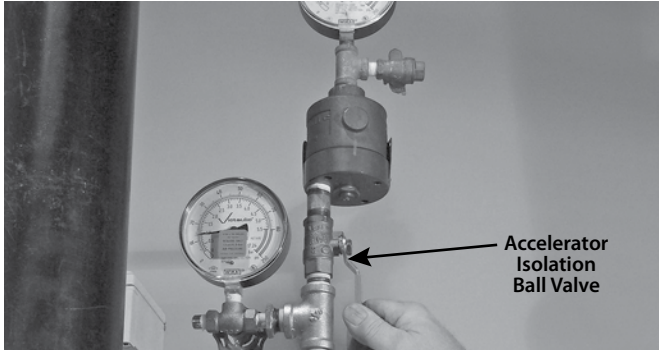

13. If a Series 746-LPA Dry Accelerator is installed, open the isolation ball valve.

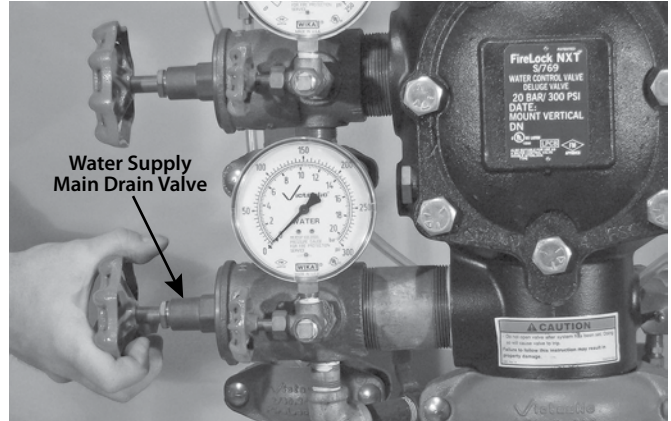

16. Close the water supply main drain valve when a steady flow of water occurs.

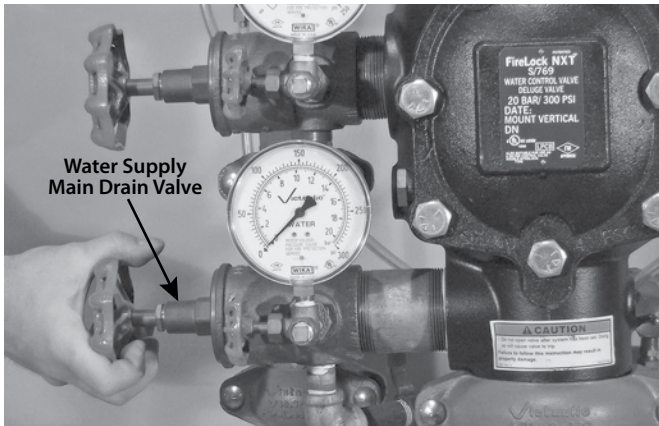

14. Open the water supply main drain valve.

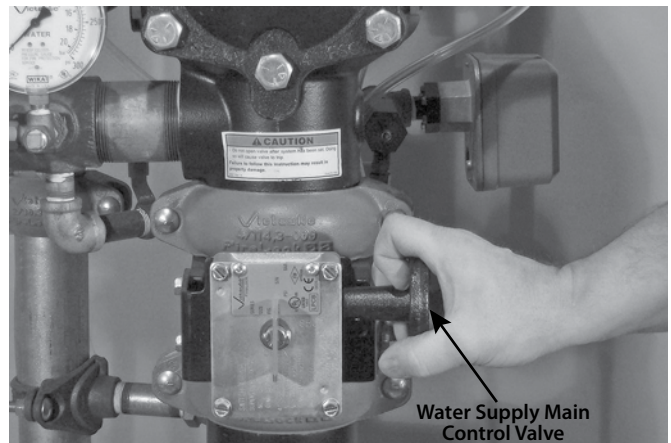

17. Open the water supply main control valve fully.

18. Confirm that all valves are in their normal operating positions (refer to the table below).

CAUTION

- Take precautions when opening the water supply main control valve, since water will flow from all open system valves. Failure to follow this instruction could result in property damage.

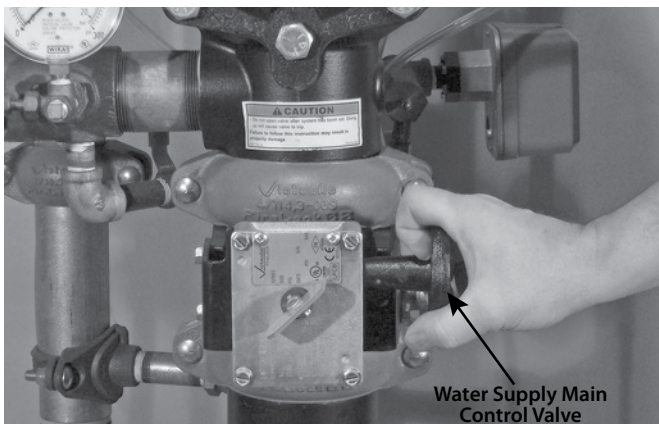

15. Open the water supply main control valve slowly until water flows steadily from the open water supply main drain valve.

Valve	Normal Operating Position
Diaphragm-Charge-Line Ball Valve	Open
Alarm Test Ball Valve	Closed
Water Supply Main Control Valve	Open
Water Supply Main Drain Valve	Closed
System Main Drain Valve	Closed
Slow-Fill Ball Valve of the Victaulic AMTA (if applicable)	Open
Fast-Fill Ball Valve of the Victaulic AMTA (if applicable)	Closed
Isolation Ball Valve for Series 746-LPA Dry Accelerator (if applicable)	Open
¼-Turn Vent Ball Valve for Series 746-LPA Dry Accelerator (if applicable)	Closed

19. Notify the authority having jurisdiction, remote station alarm monitors, and those in the affected area that the valve is back in service.

20. Provide test results to the authority having jurisdiction, if required.

FireLock NXT™ AutoConvert Preaction Valve

SERIES 769

Preaction Electric AutoConvert Dry Trim

REQUIRED OPERATIONAL (TRIP) TESTS

PARTIAL OPERATIONAL (TRIP) TEST

⚠ WARNING

- The building owner or their representative is responsible for maintaining the fire protection system in proper operating condition.
- To ensure proper system operation, valves must be inspected in accordance with current NFPA-25 requirements or in accordance with the requirements of the local authority having jurisdiction (whichever is more stringent). Always refer to the instructions in this manual for additional inspection and testing requirements.
- The frequency of inspections must be increased in the presence of contaminated water supplies, corrosive/scaling water supplies, and corrosive atmospheres.
- Depressurize and drain the piping system before attempting to install, remove, adjust, or maintain any Victaulic products.

Failure to follow these instructions could cause system failure, resulting in death, serious personal injury, and property damage.

Partial operational (trip) tests are required to confirm proper valve operation; however, this test does not confirm full system operation. Victaulic recommends performing the partial operational (trip) test annually (at minimum). **NOTE:** The frequency of the partial operational (trip) test must be increased in the presence of contaminated water supplies, corrosive/scaling water supplies, and corrosive atmospheres. In addition, the authority having jurisdiction in the area may require partial operational (trip) tests on a more frequent basis. Verify these requirements by contacting the authority having jurisdiction in the affected area.

1. Notify the authority having jurisdiction, remote station alarm monitors, and those in the affected area that the partial operational (trip) test will be performed.
2. Record the water supply pressure and system air pressure.

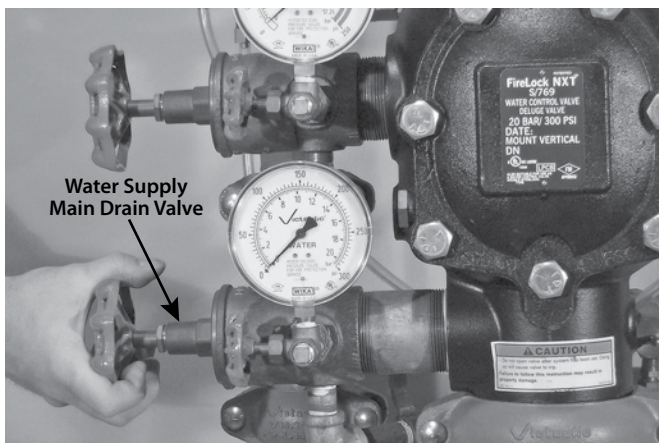

3. Open the water supply main drain valve fully to flush the water supply of any contaminants.

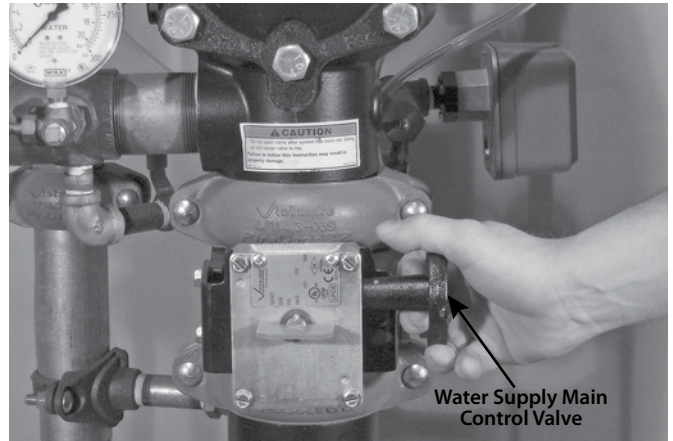

4. Close the water supply main control valve to the point where additional closure will not provide flow through the water supply main drain valve.
5. **ACTIVATE THE ELECTRICAL PORTION OF THE SYSTEM TO ENERGIZE THE SOLENOID.**

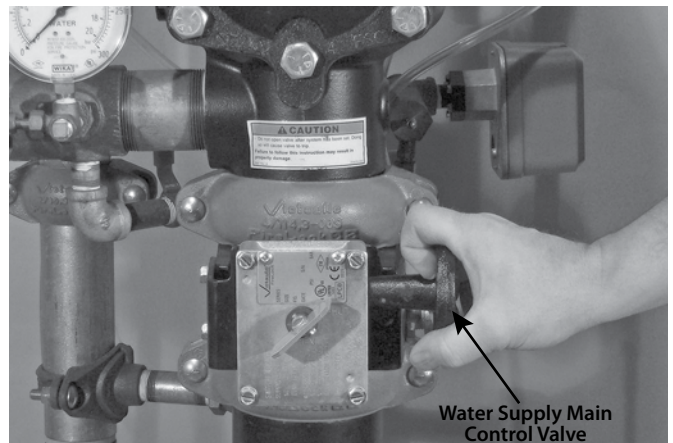

6. Open the water supply main control valve slowly until a small amount of water flows through the water supply main drain valve.

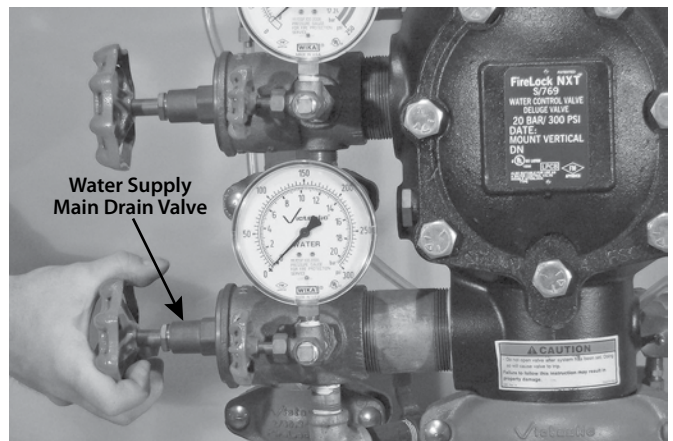

7. Close the water supply main drain valve.

FireLock NXT™ AutoConvert Preaction Valve

SERIES 769

Preaction Electric AutoConvert Dry Trim

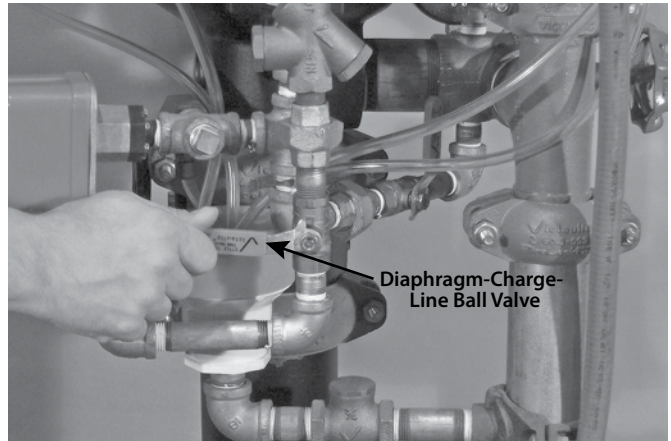
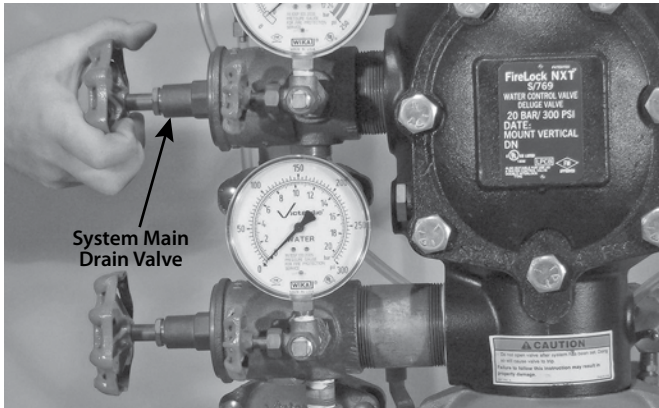

8. Open the remote system test valve (inspector’s test connection) or the system main drain valve to simulate an open sprinkler. **NOTE:** The system main drain valve is shown above.
9. Record the system air pressure when the valve operates, along with any other information required by the authority having jurisdiction.
10. Confirm that the diaphragm charge line’s pressure drops to zero and that water is flowing through the auto drain and actuators to the drip cup.

14. Close the diaphragm-charge-line ball valve.
15. Perform all steps in the “Placing the System in Service” section.

FULL OPERATIONAL (TRIP) TEST

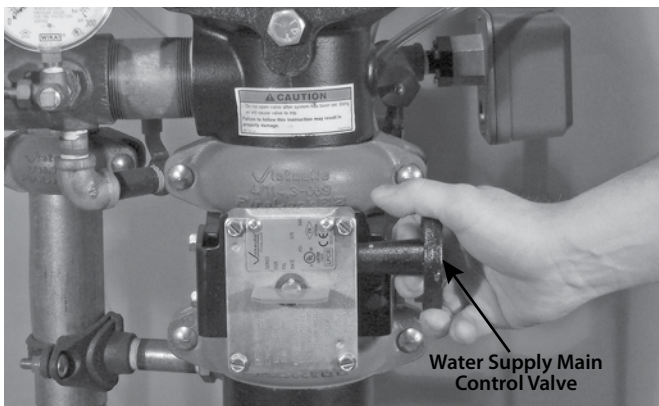

⚠ WARNING

- The building owner or their representative is responsible for maintaining the fire protection system in proper operating condition.
- To ensure proper system operation, valves must be inspected in accordance with current NFPA-25 requirements or in accordance with the requirements of the local authority having jurisdiction (whichever is more stringent). Always refer to the instructions in this manual for additional inspection and testing requirements.
- The frequency of inspections must be increased in the presence of contaminated water supplies, corrosive/scaling water supplies, and corrosive atmospheres.
- Depressurize and drain the piping system before attempting to install, remove, adjust, or maintain any Victaulic products.

Failure to follow these instructions could cause system failure, resulting in death, serious personal injury, and property damage.

11. Close the water supply main control valve fully.

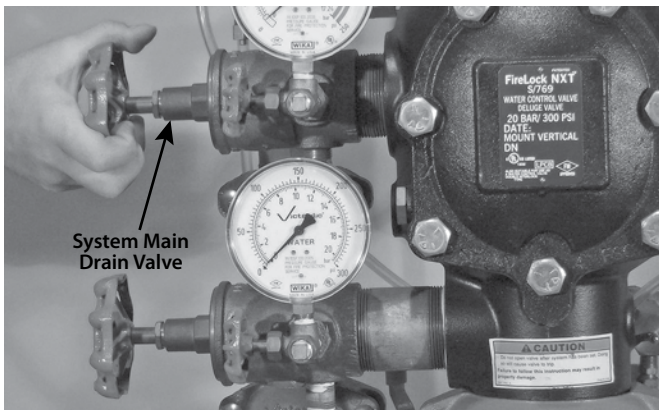

Victaulic recommends the full operational (trip) test every 3 years (at minimum). **NOTE:** The frequency of the full operational (trip) test must be increased in the presence of contaminated water supplies, corrosive/scaling water supplies, and corrosive atmospheres. This test allows a full flow of water into the sprinkler system; therefore, this test must be performed when there is no chance for freezing conditions. In addition, the authority having jurisdiction in the area may require full operational (trip) tests on a more frequent basis. Verify these requirements by contacting the authority having jurisdiction in the affected area.

12. Close the remote system test valve (inspector’s test connection) or the system main drain valve. **NOTE:** The system main drain valve is shown above.
13. **SHUT OFF THE AIR SUPPLY.**

1. Notify the authority having jurisdiction, remote station alarm monitors, and those in the affected area that the full operational (trip) test will be performed.
2. Record the water supply pressure and system air pressure.

FireLock NXT™ AutoConvert Preaction Valve

SERIES 769

Preaction Electric AutoConvert Dry Trim

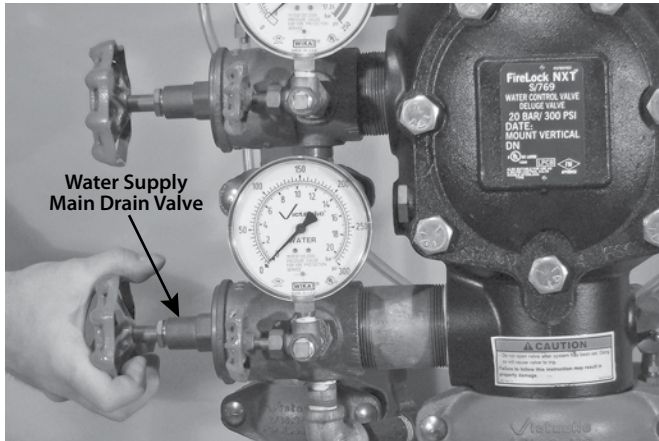

3. Open the water supply main drain valve fully to flush the water supply of any contaminants.

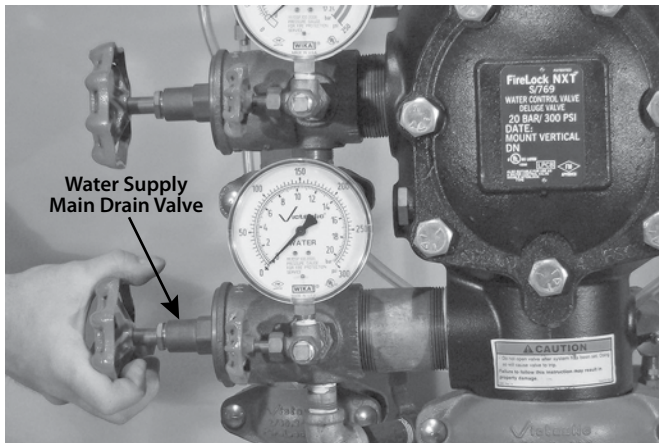

4. Close the water supply main drain valve.
5. **ACTIVATE THE ELECTRICAL PORTION OF THE SYSTEM TO ENERGIZE THE SOLENOID.**
6. Open the remote system test valve (inspector's test connection) to simulate the operation of a sprinkler.
7. Record the following:
 - 7a. Time between opening the remote system test valve (inspector's test connection) to the operation of the preaction valve
 - 7b. System air pressure when the valve operated
 - 7c. Time from opening the remote system test valve (inspector's test connection) to when water flows from the test connection's outlet
 - 7d. All information required by the authority having jurisdiction
8. Confirm that all alarms operate properly.
9. Continue to run water until it is clear.

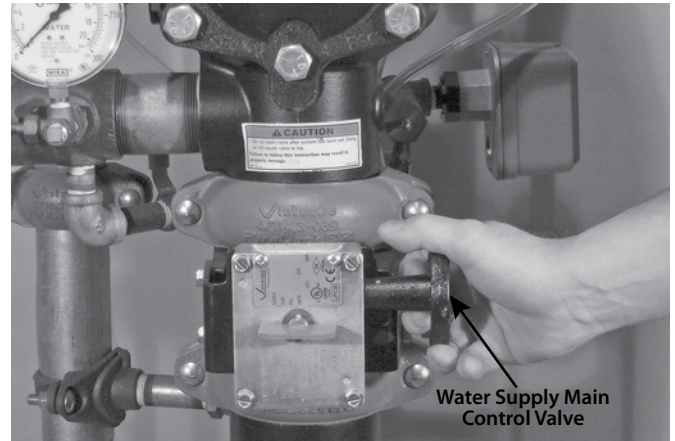

10. Close the water supply main control valve.

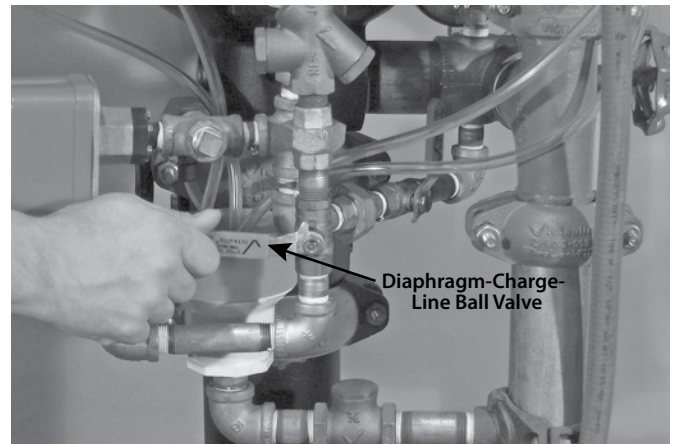

11. Close the diaphragm-charge-line ball valve.
12. **SHUT OFF THE AIR SUPPLY.**

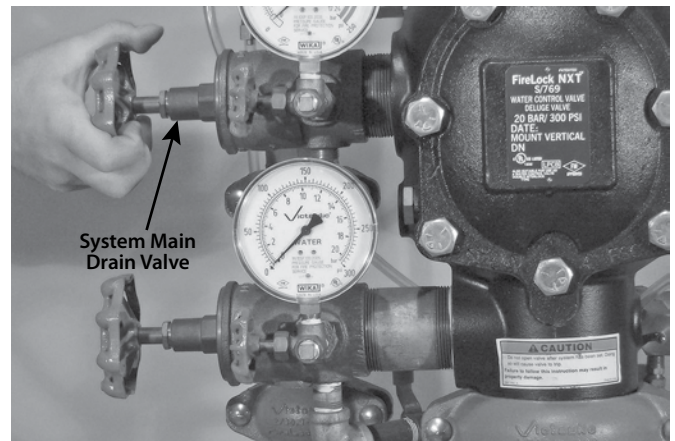

13. Open the system main drain valve to drain the system.
14. After the system is properly drained, close the remote system test valve (inspector's test connection).

FireLock NXT™ AutoConvert Preaction Valve

SERIES 769

Preaction Electric AutoConvert Dry Trim

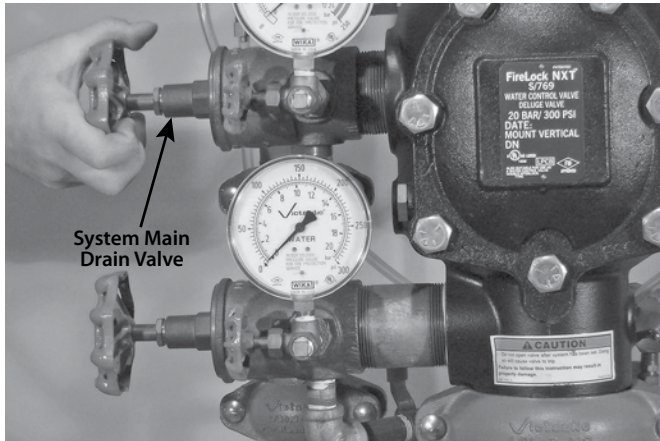

System Main Drain Valve

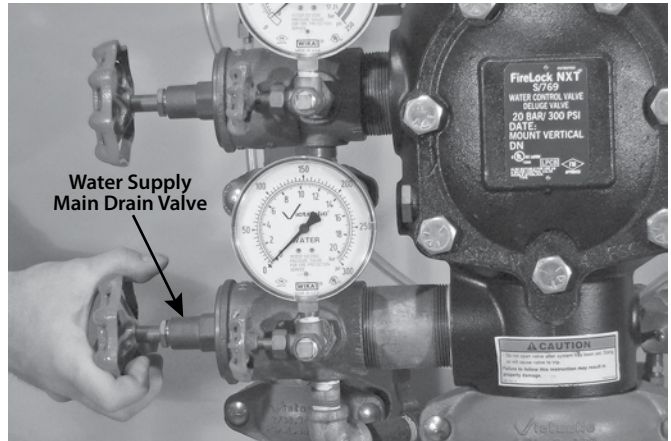

Water Supply Main Drain Valve

15. Close the system main drain valve.
16. Perform all steps in the “Placing the System in Service” section.

2. Open the water supply main drain valve fully to flush the water supply of any contaminants.

REQUIRED INTERNAL INSPECTION

Inspect internal components on a frequency required by the current NFPA-25 code. The authority having jurisdiction in the area may require these inspections on a more frequent basis. Verify these requirements by contacting the authority having jurisdiction in the affected area.

⚠ WARNING	
	<ul style="list-style-type: none"> Depressurize and drain the piping system before attempting to remove the cover plate from the valve. <p>Failure to follow this instruction could result in serious personal injury and/or property damage.</p>

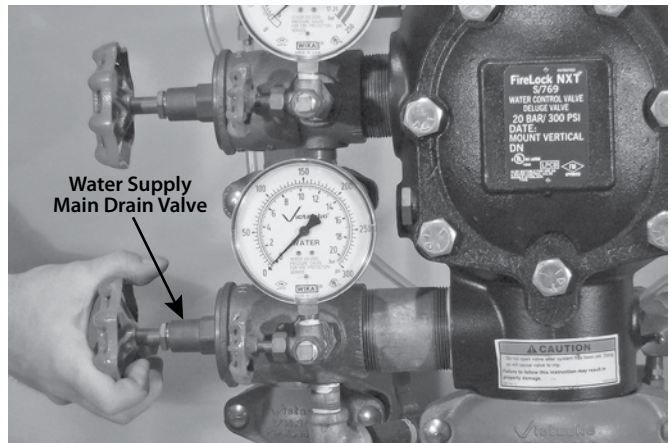

Water Supply Main Drain Valve

⚠ CAUTION	
	<ul style="list-style-type: none"> Any activities that require taking the valve out of service may eliminate the fire protection provided. Before servicing or testing the system, notify the authority having jurisdiction. Consideration of a fire patrol should be given in the affected areas. <p>Failure to follow these instructions could result in serious personal injury and/or property damage.</p>

1. Notify the authority having jurisdiction, remote station alarm monitors, and those in the affected area that the system is being taken out of service.

3. Close the water supply main drain valve.

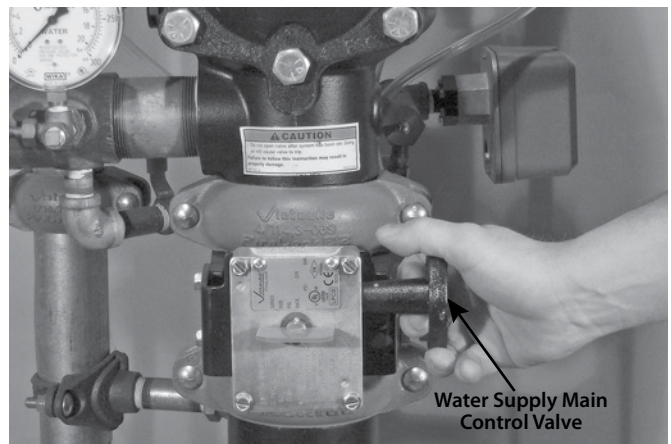

Water Supply Main Control Valve

4. Close the water supply main control valve to take the system out of service.

FireLock NXT™ AutoConvert Preaction Valve

SERIES 769

Preaction Electric AutoConvert Dry Trim

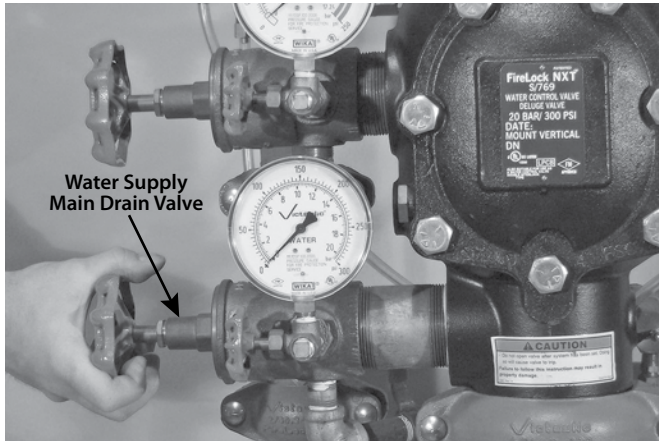

Water Supply Main Drain Valve

5. Open the water supply main drain valve.
6. Confirm that water is not flowing from the water supply main drain valve.

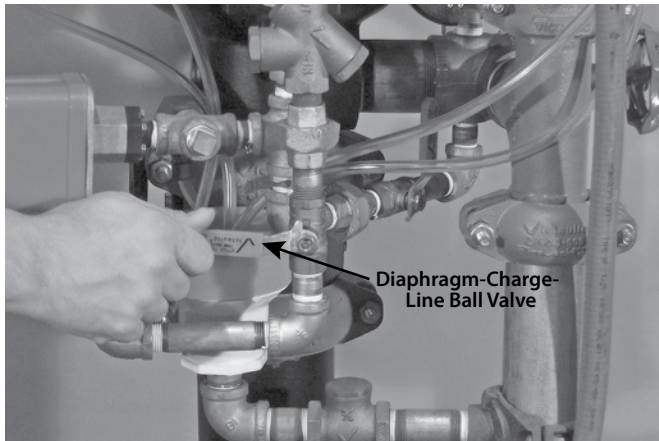

Diaphragm-Charge-Line Ball Valve

7. Close the diaphragm-charge-line ball valve.

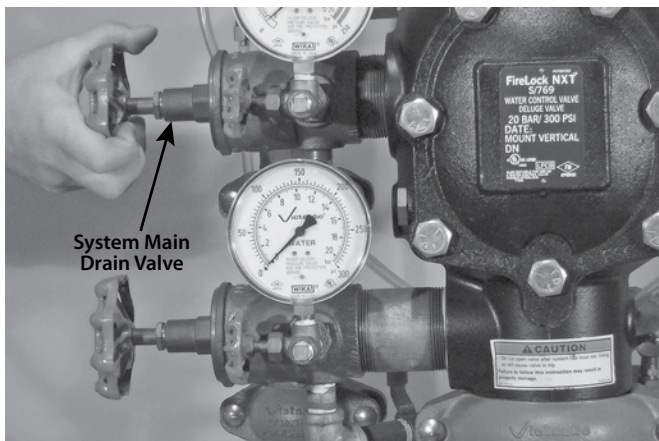

System Main Drain Valve

8. Open the system main drain valve to drain any water that has accumulated and to release system air pressure.
- NOTE:** If the system has operated, open the remote system test valve (inspector's test connection) and any auxiliary drain valves.

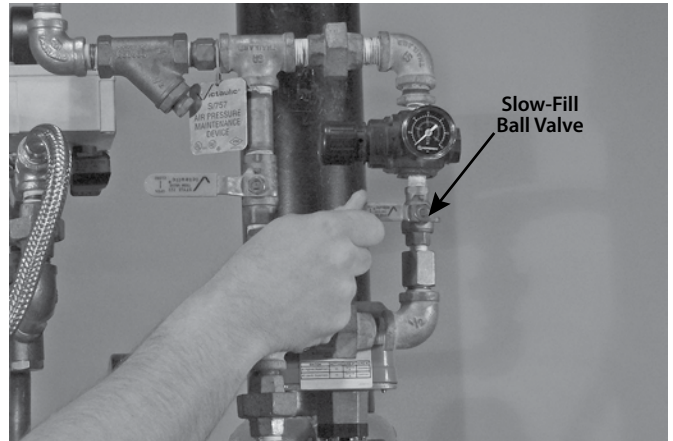

Slow-Fill Ball Valve

9. Close the slow-fill ball valve on the AMTA.

⚠ WARNING	
	<ul style="list-style-type: none"> • Make sure the valve is depressurized and drained completely before the cover plate bolts are removed.
	<p>The cover plate could blow off if the cover plate bolts are removed while the valve is pressurized, resulting in serious personal injury and/or property damage.</p>

10. **ACTIVATE THE ELECTRICAL PORTION OF THE SYSTEM TO ENERGIZE THE SOLENOID, OR PUSH DOWN ON THE AUTO DRAIN SCREW TO REMOVE PRESSURE IN THE DIAPHRAGM CHARGE LINE.**
11. **OPEN THE MANUAL PULL STATION.**

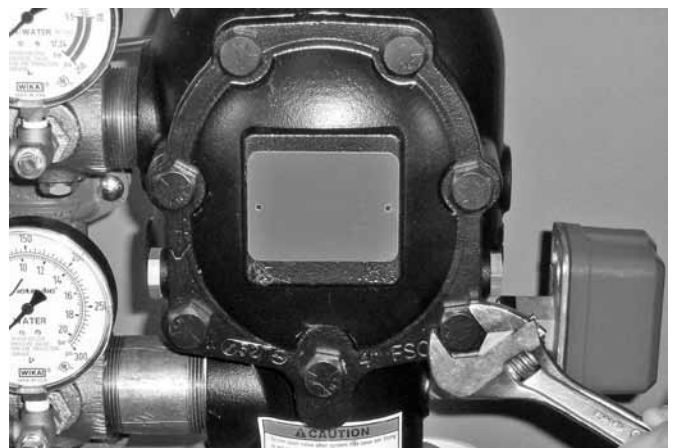

12. After all pressure is released from the system, loosen the cover plate bolts slowly. **NOTE:** DO NOT remove any cover plate bolts until all cover plate bolts are loosened.
- 12a. Remove all cover plate bolts, along with the cover plate and cover plate gasket. **NOTE:** The 1 ½-inch/48.3-mm and 2-inch/60.3-mm valve sizes contain washers under the heads of the cover plate bolts. Keep these washers for re-installation.

FireLock NXT™ AutoConvert Preaction Valve

SERIES 769

Preaction Electric AutoConvert Dry Trim

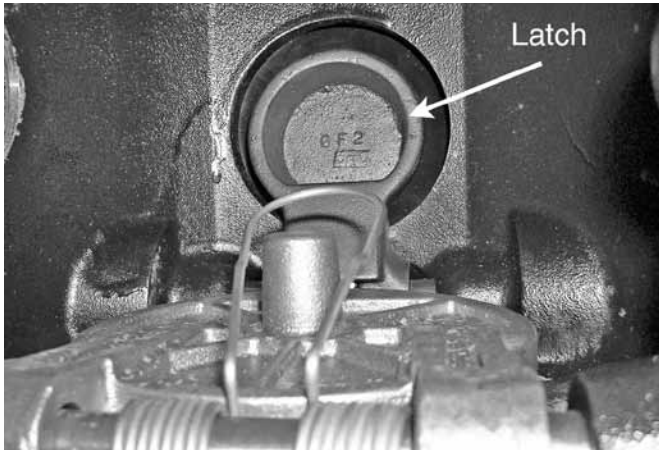

13. Push the latch back (toward the diaphragm).



16. Inspect the clapper for freedom of movement and physical damage. Replace any damaged or worn parts by following the applicable instructions in the “Maintenance” section.
17. Re-install the cover plate by following the “Installing the Cover Plate Gasket and Cover Plate” section.
18. Place the system back in service by following the “Placing the System in Service” section.

CAUTION

- **DO NOT use solvents or abrasives on or near the valve body seat ring.**

Failure to follow this instruction could prevent the clapper from sealing, resulting in improper valve operation and/or valve leakage.

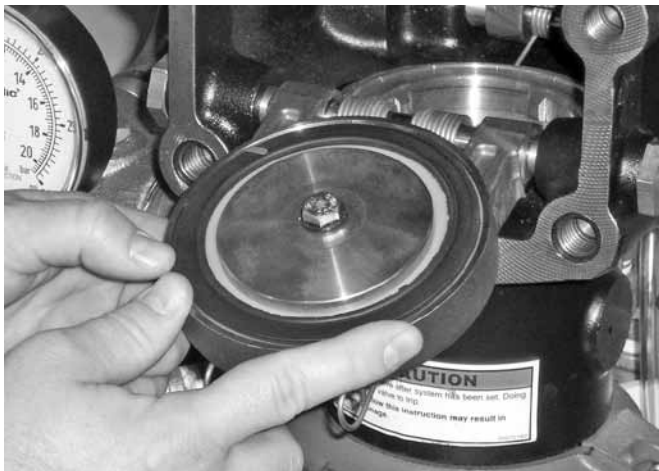

14. Rotate the clapper out of the valve body. Inspect the clapper seal and seal-retaining ring. Wipe away any contaminants, dirt, and mineral deposits. Clean out any holes that are plugged in the valve-body seat ring. **DO NOT USE SOLVENTS OR ABRASIVES.**
15. While the clapper is rotated out of the valve body, pull the latch forward to inspect the diaphragm. If the diaphragm shows any signs of wear or damage, replace it with a new, Victaulic-supplied diaphragm. Refer to the “Removing and Replacing the Diaphragm Assembly” section.

FireLock NXT™ AutoConvert Preaction Valve

SERIES 769

Preaction Electric AutoConvert Dry Trim

MAINTENANCE

The following sections instruct on how to remove and replace internal valve components. Care must be taken to avoid damage to parts during removal and installation.

⚠ WARNING



- Depressurize and drain the piping system before attempting to remove the cover plate from the valve.

Failure to follow this instruction could result in serious personal injury and/or property damage.

⚠ CAUTION



- Any activities that require taking the valve out of service may eliminate the fire protection provided.
- Before servicing or testing the system, notify the authority having jurisdiction.
- Consideration of a fire patrol should be given in the affected areas.

Failure to follow these instructions could result in serious personal injury and/or property damage.

REMOVING AND REPLACING THE CLAPPER SEAL

1. Perform steps 1 – 13 of the “Required Internal Inspection” section.



2. Remove the seal assembly bolt/bolt seal from the clapper seal.



3. Remove the seal-retaining ring.

⚠ CAUTION

- **DO NOT** pry the seal washer out of the clapper seal from the inner hole.

Failure to follow this instruction could damage the seal washer, resulting in improper clapper sealing and valve leakage.

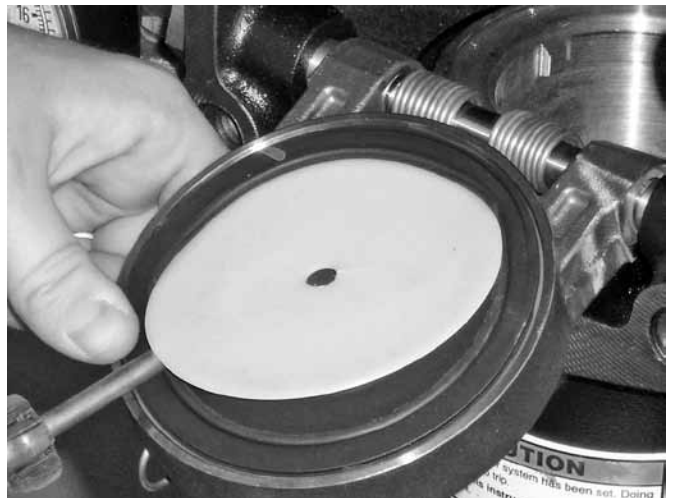

4. Pry the edge of the seal washer from inside the clapper seal, as shown above. **DO NOT PRY THE SEAL WASHER OUT FROM THE INNER HOLE.**
5. Remove the seal washer from the clapper seal. Dry up any moisture that is under the seal washer and on the clapper seal.

⚠ CAUTION

- Use only Victaulic-supplied replacement parts.

Failure to follow this instruction could cause improper valve operation, resulting in property damage.

FireLock NXT™ AutoConvert Preaction Valve

SERIES 769

Preaction Electric AutoConvert Dry Trim



6. Pry the clapper seal, along with the seal ring, out of the clapper. Inspect the clapper seal. If the clapper seal is torn or worn, replace it with a new, Victaulic-supplied clapper seal. If replacing the clapper seal assembly with a new assembly, skip to step 7.

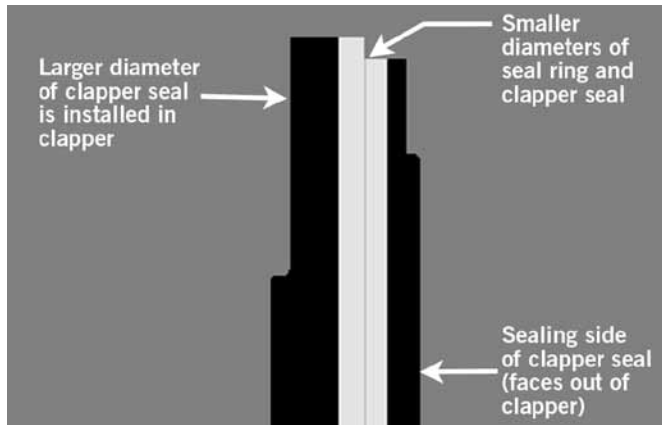

- 6a. **If using the same clapper seal assembly and the seal ring was removed from the clapper seal in the previous step:** Re-insert the seal ring carefully underneath the outer lip of the clapper seal. Make sure the smaller diameter of the seal ring is toward the sealing surface of the clapper seal.

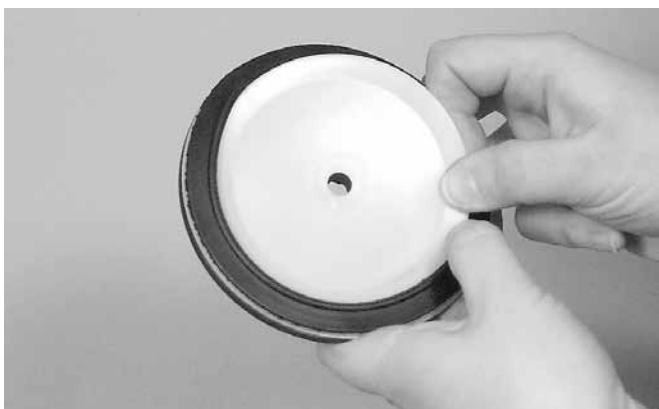

7. Insert the seal washer carefully underneath the sealing lip of the gasket.
 8. Remove any contaminants, dirt, and mineral deposits from the clapper.



9. Install the clapper seal into the clapper carefully. Make sure the seal ring snaps into the clapper completely.



10. Place the seal-retaining ring onto the seal washer of the clapper seal. Install the seal-assembly bolt/bolt seal through the seal-retaining ring and clapper.

FireLock NXT™ AutoConvert Preaction Valve

SERIES 769

Preaction Electric AutoConvert Dry Trim



11. Tighten the seal-assembly bolt/bolt seal to the torque value, listed in the table below, to ensure a proper seal.

REQUIRED SEAL-ASSEMBLY BOLT/BOLT SEAL TORQUES

Size		Torque
Nominal Size inches	Actual Outside Diameter inches mm	inch-lbs N•m
1½	1.900 48.3	40 5
2	2.375 60.3	40 5
2½	2.875 73.0	90 10
76.1 mm	3.000 76.1	90 10
3	3.500 88.9	90 10
4	4.500 114.3	110 12
165.1 mm	6.500 165.1	160 18
6	6.625 168.3	160 18
8	8.625 219.1	160 18

12. Replace the cover plate by following the “Installing the Cover Plate Gasket and Cover Plate” section.
13. Place the system back in service by following the “Placing the System in Service” section.

REMOVING AND REPLACING THE CLAPPER ASSEMBLY

1. Perform steps 1 – 13 of the “Required Internal Inspection” section.

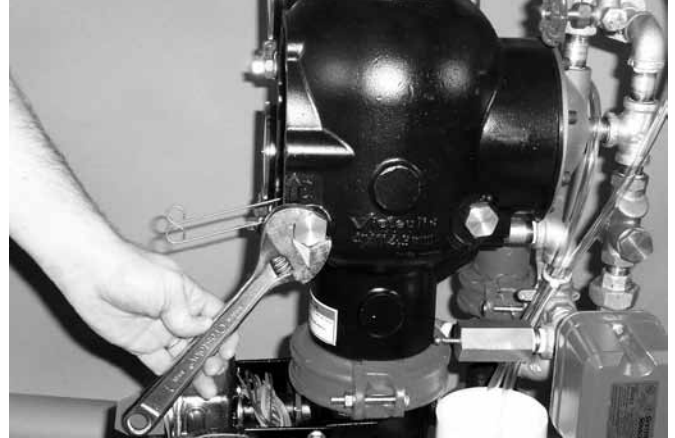

2. Remove the clapper shaft bushings from the valve body.

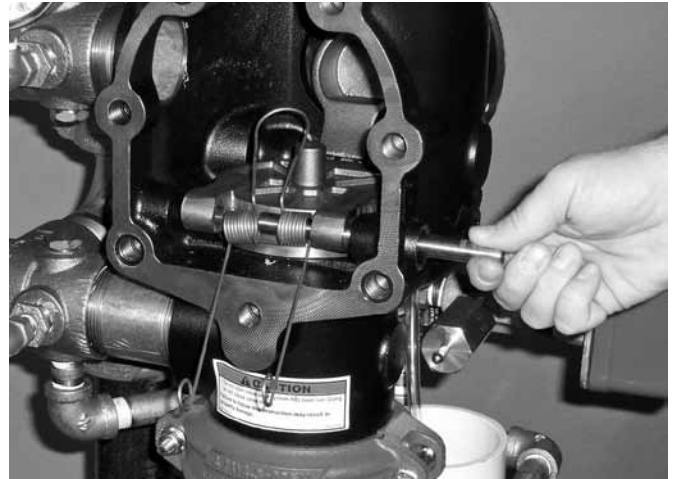

3. Remove the clapper shaft. **NOTE:** As the shaft is being removed, the clapper spring will drop out of position. Keep the clapper spring for re-installation.



4. Remove the clapper from the valve body.

FireLock NXT™ AutoConvert Preaction Valve

SERIES 769

Preaction Electric AutoConvert Dry Trim

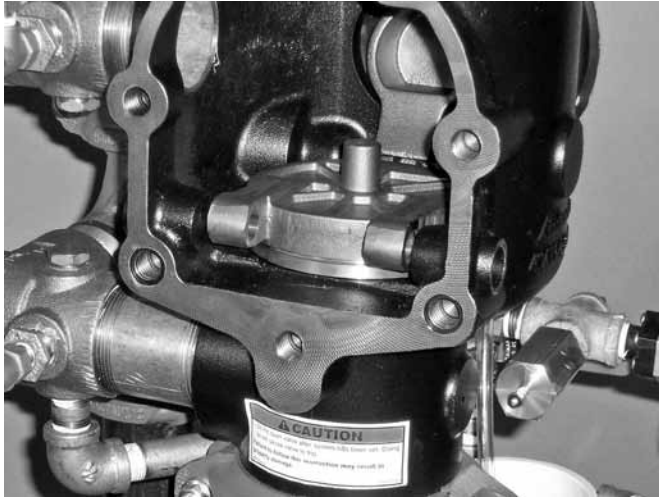

- Place the new clapper assembly onto the valve-body seat ring. Make sure the holes in the clapper arms align with the holes in the valve body.

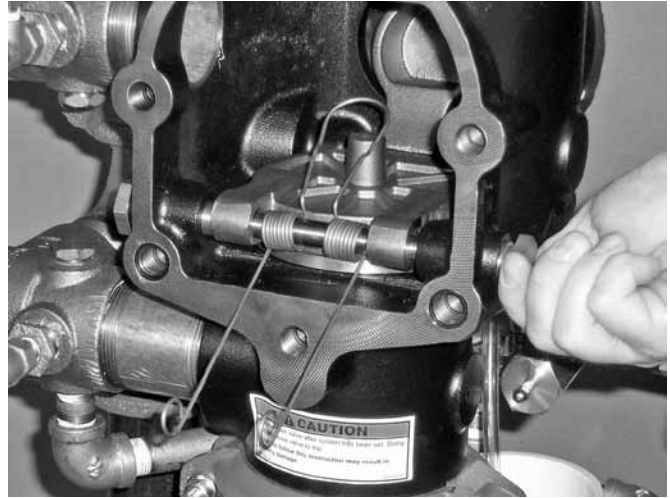

- Apply thread sealant to the clapper shaft bushings. Install the clapper shaft bushings into the valve body until hand-tight.
- Tighten the clapper shaft bushings until metal-to-metal contact occurs with the valve body.

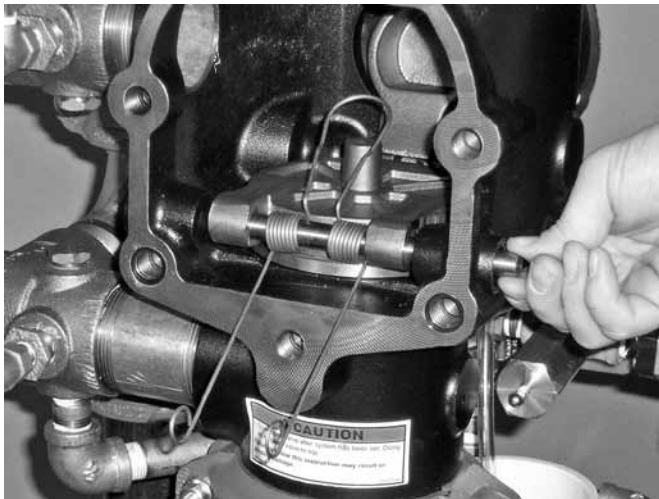

- Insert the clapper shaft halfway into the valve body.
- Install the clapper spring onto the clapper shaft. Make sure the loop of the clapper spring is facing toward the clapper, as shown above.
- Finish inserting the clapper shaft through the clapper arm and valve body.



- Check the clapper for freedom of movement.
- Replace the cover plate by following the "Installing the Cover Plate Gasket and Cover Plate" section.
- Place the system back in service by following the "Placing the System in Service" section.

FireLock NXT™ AutoConvert Preaction Valve

SERIES 769

Preaction Electric AutoConvert Dry Trim

INSTALLING THE COVER PLATE GASKET AND COVER PLATE

CAUTION

- Use only Victaulic-supplied replacement parts.
Failure to follow this instruction could cause improper valve operation, resulting in property damage.

1. Verify that the cover plate gasket is in good condition. If the gasket is torn or worn, replace it with a new, Victaulic-supplied gasket.

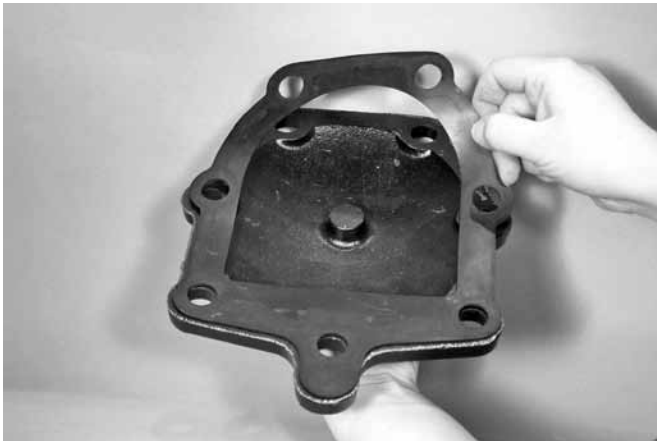

2. Align the holes of the cover plate gasket with the holes in the cover plate.



3. Insert one cover plate bolt through the cover plate and cover plate gasket to ease alignment. **NOTE:** For 1 1/2-inch/48.3-mm and 2-inch/60.3-mm valve sizes, a washer must be installed under the head of each cover plate bolt.

CAUTION

- DO NOT over-tighten the cover plate bolts.
Failure to follow this instruction could cause damage to the cover plate gasket, resulting in valve leakage.



4. Align the cover plate/cover plate gasket to the valve. Make sure the clapper spring's arms are rotated to their installed position. Tighten all cover plate bolts into the cover plate/valve body.
5. Torque all cover plate bolts in an even, crossing pattern. Refer to the "Required Cover Plate Bolt Torques" table below for the required torque values. DO NOT over-tighten the cover plate bolts.

REQUIRED COVER PLATE BOLT TORQUES

Size		Torque
Nominal Size inches	Actual Outside Diameter inches mm	ft-lbs N•m
1 1/2	1.900 48.3	30 41
2	2.375 60.3	30 41
2 1/2	2.875 73.0	60 81
76.1 mm	3.000 76.1	60 81
3	3.500 88.9	60 81
4	4.500 114.3	100 136
165.1 mm	6.500 165.1	115 156
6	6.625 168.3	115 156
8	8.625 219.1	100 136

6. Place the system back in service by following the "Placing the System in Service" section.

FireLock NXT™ AutoConvert Preaction Valve

SERIES 769

Preaction Electric AutoConvert Dry Trim

REMOVING AND REPLACING THE DIAPHRAGM ASSEMBLY

1. Remove the system from service by following steps 1 – 11 of the “Required Internal Inspection” section.
2. Break the unions that connect the trim to the diaphragm cover. Refer to the applicable trim drawing for details.

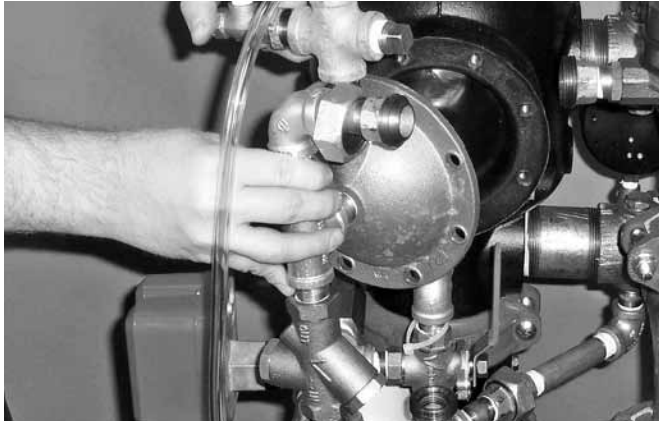

3. Remove the cap screws from the diaphragm cover, and pull the diaphragm cover/trim off the valve.

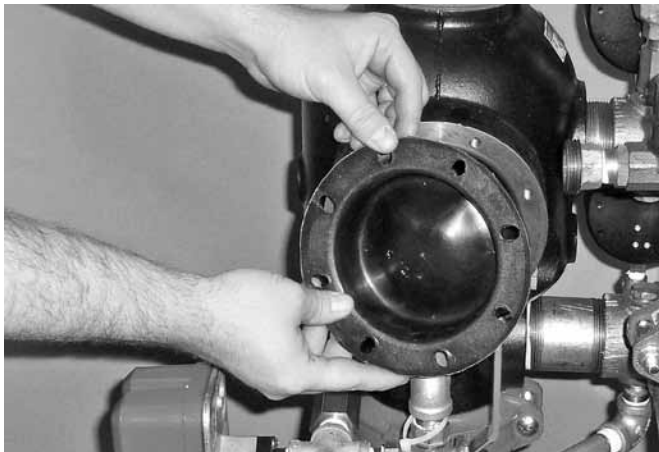

4. Remove the diaphragm from the valve body.



5. Clean the back of the valve body to remove any debris that may interfere with proper diaphragm seating.

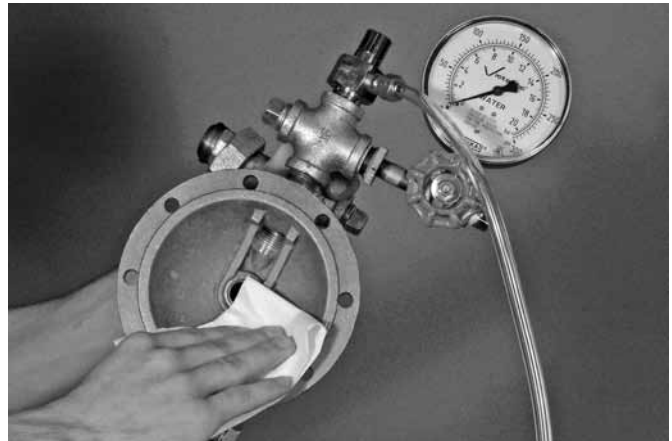

- 5a. Clean the inside of the diaphragm cover to remove any foreign material.

CAUTION

- Use caution when installing a new diaphragm into the valve body.

Failure to follow this instruction could cause damage to the diaphragm, resulting in improper valve operation and valve leakage.

6. Replace the diaphragm with a new, Victaulic-supplied diaphragm. Align the holes in the diaphragm with the holes in the valve body. Be careful not to damage the diaphragm during installation.

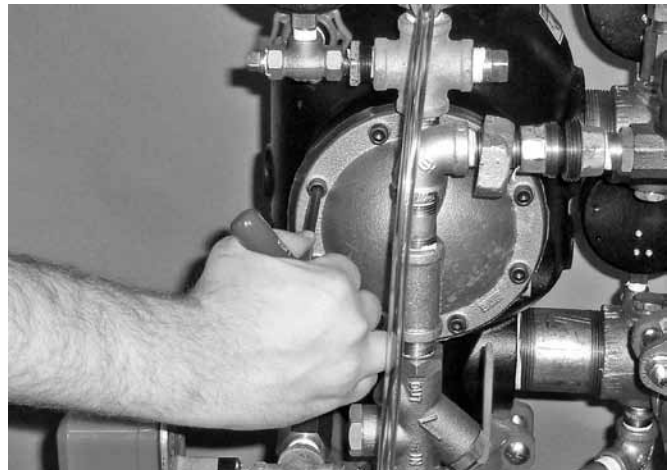

7. Align the holes of the diaphragm cover with the holes in the diaphragm/valve body. Tighten all cap screws into the diaphragm cover/valve body.
8. Re-attach the trim at the unions that were loosened in step 2. Refer to the applicable trim drawing for details. **MAKE SURE ALL UNIONS THAT WERE LOOSENEED TO PERMIT ACCESS TO THE DIAPHRAGM COVER ARE RE-TIGHTENED BEFORE ATTEMPTING TO PLACE THE SYSTEM BACK IN SERVICE.**
9. Place the system back in service by following the “Placing the System in Service” section.

FireLock NXT™ AutoConvert Preaction Valve

SERIES 769

Preaction Electric AutoConvert Dry Trim

REPLACING THE STRAINER SCREEN FOR SERIES 776 LOW-PRESSURE ACTUATORS

1. Remove the system from service by following steps 1 – 11 of the “Required Internal Inspection” section.
2. Remove the Series 776 Low-Pressure Actuator from the trim. Refer to the applicable trim drawing for details.



3. Remove the strainer assembly from the Series 776 Low-Pressure Actuator, as shown above. Discard the strainer screen only.

CAUTION

- **DO NOT re-use strainer screens. After removal, the old strainer screen must be replaced with a new, Victaulic-supplied screen.**

Failure to follow this instruction could cause improper valve operation, resulting in property damage.

4. Use only a new, Victaulic-supplied strainer screen. Insert the strainer screen into the strainer assembly.
5. Install the strainer assembly into the Series 776 Low-Pressure Actuator carefully. Avoid damage to the o-ring seals.
6. Re-install the Series 776 Low-Pressure Actuator into the trim. Refer to the applicable trim drawing for details.
7. Place the system back in service by following the “Placing the System in Service” section.

FireLock NXT™ AutoConvert Preaction Valve

SERIES 769

Preaction Electric AutoConvert Dry Trim

TROUBLESHOOTING – SERIES 776 LOW-PRESSURE ACTUATOR

Problem	Possible Cause	Solution
When the Auto Vent Sleeve of the Series 776 Low-Pressure Actuator is pulled up, the screw does not stay set in the "UP" position.	The Series 776 Low-Pressure Actuator is not receiving enough air.	Increase the air pressure going into the Series 776 Low-Pressure Actuator.
	The Series 776 Low-Pressure Actuator has a broken seal.	If the above procedure does not work, contact Victaulic.
Water is leaking through the Series 776 Low-Pressure Actuator.	The air chamber of the Series 776 Low-Pressure Actuator is not set.	Make sure the vent seal of the Series 776 Low-Pressure Actuator is in the set position and the air chamber is pressurized.
	The strainer on the Series 776 Low-Pressure Actuator is clogged.	Replace the strainer screen of the Series 776 Low-Pressure Actuator. Refer to the "Replacing the Strainer Screen for Series 776 Low-Pressure Actuators" section.
	The Series 776 Low-Pressure Actuator has a ripped diaphragm.	If water still leaks through the Series 776 after performing the above procedures, contact Victaulic.
No water is passing through the Series 776 Low-Pressure Actuator.	The strainer on the diaphragm charge line is clogged.	Disassemble and clean the diaphragm charge line strainer. Refer to the applicable trim drawing for details.

TROUBLESHOOTING – SERIES 746-LPA DRY ACCELERATOR

Problem	Possible Cause	Solution
The valve operates without sprinkler activation.	There is a loss of air pressure in the lower inlet chamber of the Series 746-LPA Dry Accelerator.	Check for air loss at the lower chamber seal. If a leak is present, turn the adjustment nut counterclockwise to seal.
		Check for any leaks in the system and trim. Confirm that the AMTA is operating properly.
The Series 746-LPA Dry Accelerator does not operate within a 5-psi/0.3-Bar pressure drop in system air pressure.	There is a loss of air pressure in the upper air chamber of the Series 746-LPA Dry Accelerator.	Apply soapy water to all joints around the Series 746-LPA Dry Accelerator to check for leaks. Repair any leaks and re-test.
	The air decay rate of the system is too slow.	Make sure there are no restrictions in the remote system test valve (inspector's test connection). If the above procedures do not work, contact Victaulic.
The Series 746-LPA Dry Accelerator does not set up properly (cannot get pressure on the upper gauge, and the button pops up immediately when pressure is introduced).	The Series 746-LPA Dry Accelerator is installed upside-down.	Remove the Series 746-LPA Dry Accelerator from the trim. Turn the unit around so that the vent seal "button" is facing down (toward the actuator).

TROUBLESHOOTING – SERIES 753-E SOLENOID VALVE

Problem	Possible Cause	Solution
No water is passing through the Series 753-E Solenoid Valve.	The strainer on the diaphragm charge line is clogged.	Disassemble and clean the diaphragm charge line strainer. Refer to the applicable trim drawing for details.
The Series 776 Low Pressure Actuator does not open.	No power is going to the solenoid.	Check all electrical connections to make sure power is being supplied to the solenoid.

TROUBLESHOOTING – AUTOCONVERT TRIM ASSEMBLY

Problem	Possible Cause	Solution
When power is introduced, there is pressure loss during the decay test.	Debris is present in the 3-in-1 Strainer/Check/Restrictor assembly of the feed line.	Disassemble and clean the 3-in-1 Strainer/Check/Restrictor assembly in the feed line of the AutoConvert Trim Assembly.
	There is blow-by through the Latching Solenoid Module.	Replace the Latching Solenoid Module.
When power is not introduced, there is no pressure loss during the decay test.	A blockage is present in the trim near the Latching Solenoid Module.	Disassemble the trim at the Latching Solenoid Module, clean out any debris, and re-test the system.

FireLock NXT™ AutoConvert Preaction Valve

SERIES 769

Preaction Electric AutoConvert Dry Trim

TROUBLESHOOTING – SYSTEM

Problem	Possible Cause	Solution
The valve operates without sprinkler activation.	There is a loss of air pressure in the system or trim.	Check for any leaks in the system and trim. Confirm that the AMTA is operating properly. Consider installing a low-air supervisory switch.
	The pressure switch on the air compressor is set too low, or the compressor is not operating properly.	Increase the "ON" setting of the air compressor's pressure switch, and check the air compressor for proper operation.
Water is leaking from the drip check located in the alarm line.	Water is getting past the clapper seal and into the intermediate chamber of the valve.	Check the clapper seal and valve body seat ring for physical damage and foreign material.
	Water is under the clapper seal.	Inspect the clapper seal to make sure no water is under the seal. If water is present, remove and replace the seal. Refer to the "Removing and Replacing the Clapper Seal" section.
Air is leaking from the drip check located in the alarm line.	Air is getting past the clapper seal and into the intermediate chamber of the valve.	Check the clapper seal and valve body seat ring for physical damage and foreign material.
	Water is under the clapper seal.	Inspect the clapper seal to make sure no water is under the seal. If water is present, remove and replace the seal. Refer to the "Removing and Replacing the Clapper Seal" section.
The clapper will not latch closed.	There is no water pressure on the diaphragm.	Check the water pressure in the diaphragm charge line. Make sure the restrictor in the diaphragm charge line is clean.
	The Auto Drain is not set.	Set the Auto Drain by pulling up on the Auto Drain Sleeve.
Water is leaking from the diaphragm assembly.	The diaphragm is damaged.	Contact Victaulic.
Air is leaking from the diaphragm assembly.	The diaphragm is damaged.	Contact Victaulic.

FireLock NXT™ AutoConvert Preaction Valve

SERIES 769

Preaction Electric AutoConvert Dry Trim

For complete contact information, visit www.victaulic.com

I-769P.AC/ELEC 5666 REV B UPDATED 09/2009 Z0AC769PEL

VICTAULIC IS A REGISTERED TRADEMARK OF VICTAULIC COMPANY. © 2009 VICTAULIC COMPANY. ALL RIGHTS RESERVED. PRINTED IN THE USA.

I-769P.AC/ELEC

